



9 1 1 6

Universal converter

No. 9116V105-UK

Product version: 9116-003



- DK** ▶ PR electronics A/S tilbyder et bredt program af analoge og digitale signalbehandlingsmoduler til industriel automation. Programmet består af Isolatorer, Displays, Ex-barrierer, Temperaturtransmittere, Universaltransmittere mfl. Vi har modulerne, du kan stole på i selv barske miljøer med elektrisk støj, vibrationer og temperaturudsving, og alle produkter opfylder de strengeste internationale standarder. Vores motto »Signals the Best« er indbegrebet af denne filosofi - og din garanti for kvalitet.
- UK** ▶ PR electronics A/S offers a wide range of analog and digital signal conditioning devices for industrial automation. The product range includes Isolators, Displays, I.S. Interfaces, Temperature Transmitters, and Universal Devices. You can trust our products in the most extreme environments with electrical noise, vibrations and temperature fluctuations, and all products comply with the most exacting international standards. »Signals the Best« is the epitome of our philosophy - and your guarantee for quality.
- FR** ▶ PR electronics A/S offre une large gamme de produits pour le traitement des signaux analogiques et numériques dans tous les domaines industriels. La gamme de produits s'étend des transmetteurs de température aux afficheurs, des isolateurs aux interfaces SI, jusqu'aux modules universels. Vous pouvez compter sur nos produits même dans les conditions d'utilisation sévères, p.ex. bruit électrique, vibrations et fluctuations de température. Tous nos produits sont conformes aux normes internationales les plus strictes. Notre devise »SIGNALS the BEST« c'est notre ligne de conduite - et pour vous l'assurance de la meilleure qualité.
- DE** ▶ PR electronics A/S verfügt über ein breites Produktprogramm an analogen und digitalen Signalverarbeitungsgeräte für die industrielle Automatisierung. Dieses Programm umfasst Displays, Temperaturtransmitter, Ex- und galvanische Signaltrenner, und Universalgeräte. Sie können unsere Geräte auch unter extremen Einsatzbedingungen wie elektrisches Rauschen, Erschütterungen und Temperaturschwingungen vertrauen, und alle Produkte von PR electronics werden in Übereinstimmung mit den strengsten internationalen Normen produziert. »Signals the Best« ist Ihre Garantie für Qualität!

UNIVERSAL CONVERTER

9116

CONTENTS

Warning.....	2
Safety instructions.....	2
How to demount system 9000	4
Advanced features	5
Application.....	5
Technical characteristics.....	5
Applications.....	6
PR 4501 Display / programming front.....	7
Mounting / demounting the PR 4501/4511.....	8
Order: 9116B.....	9
Accessories	9
Electrical specifications.....	9
Configuration of sensor error check.....	15
Input signal outside range	15
Sensor error detection	15
Hardware error	16
Connections	18
Block diagram.....	19
Signal error and cable fault indications without display front.....	20
Configuration / operating the function keys.....	21
Routing diagram.....	26
Routing diagram, Advanced settings (ADV.SET).....	28
Scrolling help texts in display line 3.....	29
Graphic depiction of window	31
Graphic depiction of setpoint	32
Appendix	33
IECEX Installation Drawing.....	34
ATEX Installation Drawing.....	38
FM Installation Drawing	42
INMETRO Installation Drawing	46
Safety Manual.....	50



WARNING

The following operations should only be carried out on a disconnected device and under ESD-safe conditions:

General mounting, connection and disconnection of wires.
Troubleshooting the device.

Repair of the device and replacement of circuit breakers must be done by PR electronics A/S only.



WARNING

Do not open the front plate of the device as this will cause damage to the connector for the display / programming front PR 4501. This device contains no DIP-switches or jumpers.

SYMBOL IDENTIFICATION



Triangle with an exclamation mark: Read the manual before installation and commissioning of the device in order to avoid incidents that could lead to personal injury or mechanical damage.



The CE mark proves the compliance of the device with the essential requirements of the directives.



The double insulation symbol shows that the device is protected by double or reinforced insulation.



Ex devices have been approved according to the ATEX directive for use in connection with installations in explosive areas. See installation drawings in appendix.

SAFETY INSTRUCTIONS

DEFINITIONS

Hazardous voltages have been defined as the ranges: 75...1500 Volt DC, and 50...1000 Volt AC.

Technicians are qualified persons educated or trained to mount, operate, and also troubleshoot technically correct and in accordance with safety regulations.

Operators, being familiar with the contents of this manual, adjust and operate the knobs or potentiometers during normal operation.

RECEIPT AND UNPACKING

Unpack the device without damaging it and check whether the device type corresponds to the one ordered. The packing should always follow the device until this has been permanently mounted.

ENVIRONMENT

Avoid direct sunlight, dust, high temperatures, mechanical vibrations and shock, as well as rain and heavy moisture. If necessary, heating in excess of the stated limits for ambient temperatures should be avoided by way of ventilation.

The device must be installed in pollution degree 2 or better.

The device is designed to be safe at least under an altitude up to 2 000 m.

MOUNTING

Only technicians who are familiar with the technical terms, warnings, and instructions in the manual and who are able to follow these should connect the device.

Should there be any doubt as to the correct handling of the device, please contact your local distributor or, alternatively,

PR electronics A/S
www.prelectronics.com

The use of stranded wires is not permitted for mains wiring except when wires are fitted with cable ends.

Descriptions of input / output and supply connections are shown in the block diagram and on the side label.

The device is provided with field wiring terminals and shall be supplied from a Power Supply having double / reinforced insulation. A power switch shall be easily accessible and close to the device. The power switch shall be marked as the disconnecting unit for the device.

For installation on Power Rail 9400 the power is supplied by Power Control Unit 9410.

Year of manufacture can be taken from the first two digits in the serial number.

CALIBRATION AND ADJUSTMENT

During calibration and adjustment, the measuring and connection of external voltages must be carried out according to the specifications of this manual. The technician must use tools and instruments that are safe to use.

NORMAL OPERATION

Operators are only allowed to adjust and operate devices that are safely fixed in panels, etc., thus avoiding the danger of personal injury and damage. This means there is no electrical shock hazard, and the device is easily accessible.

CLEANING

When disconnected, the device may be cleaned with a cloth moistened with distilled water.

LIABILITY

To the extent the instructions in this manual are not strictly observed, the customer cannot advance a demand against PR electronics A/S that would otherwise exist according to the concluded sales agreement.

HOW TO DEMOUNT SYSTEM 9000

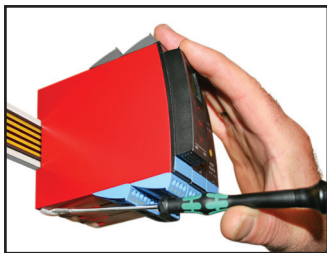

Picture 1:

By lifting the bottom lock, the device is detached from the power rail.

UNIVERSAL CONVERTER

9116

- *Input for RTD, TC, Ohm, potentiometer, mA and V*
- *Supply for 2-wire transmitters*
- *Active / passive mA output and relay output*
- *Can be supplied separately or installed on power rail, PR 9400*
- *SIL 2-certified via Full Assessment*

Advanced features

- Configuration and monitoring by way of detachable display front (PR 4501); process calibration, signal and relay simulation.
- Advanced relay configuration, e.g. setpoint, window, delay, sensor error indication and power monitoring.
- Copying of the configuration from one device to others of the same type via PR4501.
- Reduced Uo Ex data < 8.3 V for active input signals.
- TC inputs with internal or external CJC for higher accuracy.
- The device automatically detects whether it must supply an active or a passive current signal.

Application

- The device can be mounted in the safe area and in zone 2 / cl. 1 div. 2 and receive signals from zone 0, 1, 2 and zone 20, 21, 22 including M1 / Class I/II/III, Div. 1, Gr. A-G.
- Conversion and scaling of temperature, voltage, potentiometer and linear resistance signals.
- Power supply and signal isolator for 2-wire transmitters.
- Monitoring of error events and cable breakage via the individual status relay and/or a collective electronic signal via the power rail.
- The 9116 has been designed, developed and certified for use in SIL 2 applications according to the requirements of IEC 61508.

Technical characteristics

- 1 green and 1 red front LED indicate operation status and malfunction. 1 yellow LED indicates relay status.
- 2.6 kVAC galvanic isolation between input, output and supply.



APPLICATIONS

Input signals:

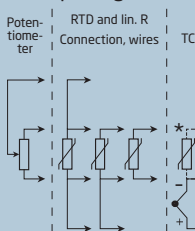

* Order separately:
CJC connector 5910Ex

Output signals:

Analogue, 0/4...20 mA and relay

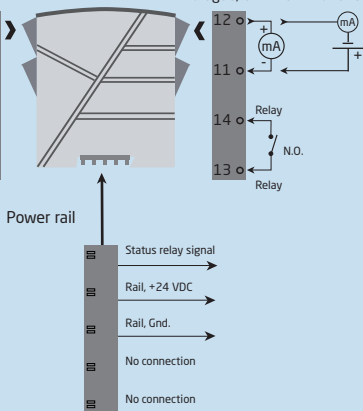

Power connection:

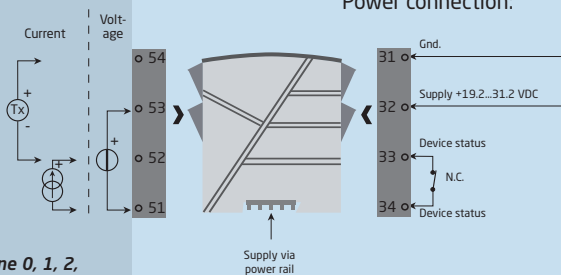

**Zone 0, 1, 2,
20, 21, 22, M1 /
Cl. I/II/III, div. 1
gr. A-G**

Zone 2 / Cl. 1, div. 2, gr. A-D or safe area

PR 4501 DISPLAY / PROGRAMMING FRONT



Functionality

The simple and easily understandable menu structure and the explanatory help texts guide you effortlessly and automatically through the configuration steps, thus making the product very easy to use. Functions and configuration options are described in the section "Configuration / operating the function keys".

Application

- Communications interface for modification of operational parameters in 9116.
- Can be moved from one 9116 device to another and download the configuration of the first unit to subsequent units.
- Fixed display for visualisation of process data and status.

Technical characteristics

- LCD display with 4 lines; Line 1 (H=5.57 mm) shows input status, line 2 (H=3.33) mm toggles between input value and tag. no. Line 3 (H=3.33 mm) shows output value and UNIT. Line 4 shows status for relay and communication and whether the device is SIL-locked. Static dot = SIL-locked and flashing dot = not SIL-locked.
- Programming access can be blocked by assigning a password. The password is saved in the device in order to ensure a high degree of protection against unauthorised modifications to the configuration.

MOUNTING / DEMOUNTING THE PR 4501/4511

1: Insert the taps of 4501/4511 into the holes at the top of the device.

2: Swing 4501/4511 into place.

Demounting of 4501/4511

3: Push the release button on the bottom of 4501/4511 and swing 4501/4511 up.

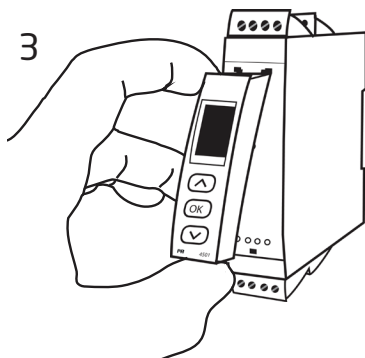
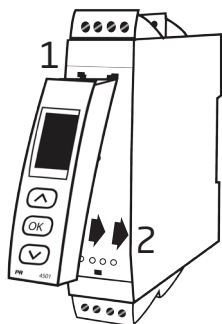

Order: 9116B

Type	Max. loop voltage
9116	U ₀ 28 VDC : 1 U ₀ 21.4 VDC : 2

Accessories

4501 = Display / programming front
4511 = Communication enabler
5910Ex = CJC connector
9400 = Power rail
9404 = Module stop for rail
9410 = Power control unit
9420 = Power supply 24 V / 120 W - Ex nAC

Electrical specifications

Environmental conditions

Specifications range -20...+60°C
Storage temperature -20...+85°C
Calibration temperature 20...28°C
Relative humidity < 95% RH (non-cond.)
Protection degree IP20
Installation in Pollution degree 2 & measurement /
overvoltage category II

Mechanical specifications:

Dimensions (HxWxD) 109 x 23.5 x 104 mm
Dimensions (HxWxD) w/ 4501 / 4511 109 x 23.5 x 116 / 131 mm
Weight approx. 185 g
Weight incl. 4501 / 4511 (approx.) 200 g / 285 g
DIN rail type DIN EN 60715 / 35 mm
Wire size 0.13...2.08 mm² AWG 26...14
stranded wire
Screw terminal torque 0.5 Nm
Vibration IEC 60068-2-6 : 2007
Vibration: 2...13.2 Hz ±1 mm
Vibration: 13.2...100 Hz ±0.7 g

Common specifications:

Supply voltage, DC	19.2...31.2 VDC
Max. consumption.....	≤ 3.5 W
Fuse.....	1.25 A SB / 250 VAC
Isolation - test / working:	
Input to any	2.6 kVAC / 300 VAC reinforced
Analogue output to supply	2.6 kVAC / 300 VAC reinforced
Status relay to supply	1.5 kVAC / 150 VAC reinforced
Communications interface	Communication enabler 4511 / Programming front 4501
Signal / noise ratio	Min. 60 dB (0...100 kHz)
Response time (0...90%, 100...10%):	
Temperature input, programmable.....	1...60 s
mA / V input, programmable	0.4...60 s

Accuracy, the greater of the general and basic values:

General values		
Input type	Absolute accuracy	Temperature coefficient
All	$\leq \pm 0.1\%$ of span	$\leq \pm 0.01\%$ of span / °C

Basic values		
Input type	Basic accuracy	Temperature coefficient
mA	$\leq \pm 16 \mu\text{A}$	$\leq \pm 1.6 \mu\text{A} / ^\circ\text{C}$
Volt	$\leq \pm 20 \mu\text{V}$	$\leq \pm 2 \mu\text{V} / ^\circ\text{C}$
Pt100, Pt200, Pt 1000	$\leq \pm 0.2^\circ\text{C}$	$\leq \pm 0.02^\circ\text{C} / ^\circ\text{C}$
Pt500, Ni100, Ni120, Ni 1000	$\leq \pm 0.3^\circ\text{C}$	$\leq \pm 0.03^\circ\text{C} / ^\circ\text{C}$
Pt50, Pt400, Ni50	$\leq \pm 0.4^\circ\text{C}$	$\leq \pm 0.04^\circ\text{C} / ^\circ\text{C}$
Pt250, Pt300	$\leq \pm 0.6^\circ\text{C}$	$\leq \pm 0.06^\circ\text{C} / ^\circ\text{C}$
Pt20	$\leq \pm 0.8^\circ\text{C}$	$\leq \pm 0.08^\circ\text{C} / ^\circ\text{C}$
Pt10	$\leq \pm 1.4^\circ\text{C}$	$\leq \pm 0.14^\circ\text{C} / ^\circ\text{C}$
TC type: E, J, K, L, N, T, U	$\leq \pm 1^\circ\text{C}$	$\leq \pm 0.1^\circ\text{C} / ^\circ\text{C}$
TC type: R, S, W3, W5, LR	$\leq \pm 2^\circ\text{C}$	$\leq \pm 0.2^\circ\text{C} / ^\circ\text{C}$
TC type: B 160...400°C	$\leq \pm 4.5^\circ\text{C}$	$\leq \pm 0.45^\circ\text{C} / ^\circ\text{C}$
TC type: B 400...1820°C	$\leq \pm 2^\circ\text{C}$	$\leq \pm 0.2^\circ\text{C} / ^\circ\text{C}$

EMC immunity influence.....	$< \pm 0.5\%$ of span
Extended EMC immunity: NAMUR NE 21, A criterion, burst.....	$< \pm 1\%$ of span

Auxiliary supplies for 9116B1:
 2-wire supply (terminal 54...52)..... 28...16.5 VDC / 0...20 mA
 Auxiliary supplies for 9116B2:
 2-wire supply (terminal 54...52)..... 21.4...16.5 VDC / 0...20 mA

RTD, linear resistance and potentiometer input:

Input type	Min. value	Max. value	Standard
Pt100	-200°C	+850°C	IEC60751
Ni100	-60°C	+250°C	DIN 43760
Linear resist.	0 Ω	10000 Ω	-
Potentiometer	10 Ω	10000 Ω	-

Input for RTD types:

Pt10*, Pt20*, Pt50*, Pt100, Pt200, Pt250, Pt300, Pt400, Pt500, Pt1000
 Ni50, Ni100, Ni120, Ni1000

Effect of sensor cable resistance

(3- / 4-wire), RTD < 0.002 Ω / Ω

Sensor error detection, RTD Programmable ON / OFF

Short circuit detection, RTD Yes

Cable resistance per wire (max.), RTD 50 Ω

Sensor current, RTD Nom. 0.2 mA

* No short circuit detection for Pt10, Pt20 and Pt50

* No short circuit detection for Lin. R_0% ≤ app. 18 Ω

TC input:

Type	Min. value	Max. value	Standard
B	+0°C	+1820°C	IEC 60584-1
E	-100°C	+1000°C	IEC 60584-1
J	-100°C	+1200°C	IEC 60584-1
K	-180°C	+1372°C	IEC 60584-1
L	-200°C	+900°C	DIN 43710
N	-180°C	+1300°C	IEC 60584-1
R	-50°C	+1760°C	IEC 60584-1
S	-50°C	+1760°C	IEC 60584-1
T	-200°C	+400°C	IEC 60584-1
U	-200°C	+600°C	DIN 43710
W3	0°C	+2300°C	ASTM E988-90
W5	0°C	+2300°C	ASTM E988-90
LR	-200°C	+800°C	GOST 3044-84

Cold junction compensation (CJC):
 via external sensor in connector 5910. 20...28°C ≤ ±1°C
 -20...20°C and 28...70°C ≤ ±2°C
 via internal CJC sensor..... ±(2.0°C + 0.4°C * Δt)
 Δt = internal temperature - ambient temperature
 Sensor error detection..... Programmable ON or OFF
 (only wire breakage)

Sensor error current:
 when detecting..... Nom. 2 μA
 else..... 0 μA

Current input:

Measurement range..... 0...20 mA
 Programmable measurement ranges..... 0...20 and 4...20 mA
 Input resistance..... Nom. 20 Ω + PTC 50 Ω
 Sensor error detection:
 Loop break 4...20 mA..... Yes
 NB: Only when input is selected as 4...20 mA

Voltage input:

Measurement range..... 0...10 VDC
 Programmable measurement ranges..... 0...1 / 0.2...1 / 0.5 / 1...5 /
 0...10 and 2...10 VDC
 Input resistance..... Nom. >10 MΩ

Current output:

Signal range (span) 0...20 mA
 Programmable signal ranges..... 0...20 / 4...20 /
 20...0 and 20...4 mA
 Load (max.)..... 20 mA / 600 Ω / 12 VDC
 Load stability..... ≤ 0.01% of span / 100 Ω
 Sensor error reaction..... 0 / 3.5 / 23 mA / none
 NAMUR NE 43 Upscale/Downscale..... 23 mA / 3.5 mA

Output limitation:

on 4...20 and 20...4 mA signals 3.8...20.5 mA
 on 0...20 and 20...0 mA signals 0...20.5 mA
 Current limit..... ≤ 28 mA

2-wire 4...20 mA output:

Signal range..... 4...20 mA
 Load stability..... ≤ 0.01% of span / 100 Ω
 Load resistance..... ≤ (Vsupply - 3.5) / 0.023 A [Ω]
 External 2-wire supply range 3.5...26 VDC
 Effect of external 2-wire supply
 voltage variation..... < 0.005% of span / V

Relay output in safe area:

Relay functions.....	Setpoint, Window, Sensor error, Power and Off
Hysteresis, in % of span / display range.....	0.1...25 / 1...25
On and Off delay.....	0...3600 s
Sensor error reaction.....	Break / Make / Hold
Max. voltage	250 VAC / 30 VDC
Max. current	2 AAC / 2 ADC
Max. AC power	500 VA / 60 W

Status relay in safe area:

Max. voltage	125 VAC / 110 VDC
Max. current	0.5 AAC / 0.3 ADC
Max. AC power	62.5 VA / 32 W

Approvals:

EMC 2004/108/EC	EN 61326-1
LVD 2006/95/EC.....	EN 61010-1
c UL us, Standard for Safety.....	UL 61010-1
EAC TR-CU 020/2011.....	EN 61326-1

Marine:

Det Norske Veritas, Ships & Offshore	Stand. f. Certific. No. 2.4
--	-----------------------------

I.S. / Ex:

ATEX 94/9/EC.....	KEMA 10ATEX0053 X
IECEX	IECEX KEM 10.0022X
c FM us.....	3038267-C
INMETRO	NCC 12.1309 X
CCOE	P337349/4
EAC Ex TR-CU 012/2011	RU C-DK.GB08.V.00410

Functional Safety:

SIL2 Certified & Fully Assessed acc. to IEC 61508

of span = of the currently selected measurement range

Configuration of sensor error check

Sensor error check:		
Device:	Configuration	Sensor error detection:
9116	ERR.ACT=NONE - OUT.ERR=NONE.	OFF
	Else:	ON

Visualisation in 4501 of:

Input signal outside range

Outside range readout (IN.LO, IN.HI): If the valid range of the A/D converter or the polynomial is exceeded.			
Input	Range	Readout	Limit
VOLT	0...1 V / 0.2...1 V	IN.LO	< -25 mV
		IN.HI	> 1.2 V
	0...10 V / 2...10 V	IN.LO	< -25 mV
		IN.HI	> 12 V
CURR	0...20 mA / 4...20 mA	IN.LO	< -1.05 mA
		IN.HI	> 25.05 mA
LIN.R	0...800 Ω	IN.LO	< -10 Ω
		IN.HI	> 900 Ω
	0...10 kΩ	IN.LO	< -10 Ω
		IN.HI	> 11 kΩ
POTM	0 - 100%	IN.LO	< -0.5 %
		IN.HI	> 100.5 %
TEMP	TC / RTD	IN.LO	< temperature range -2°C
		IN.HI	> temperature range +2°C

Display readout below . / above max. (-1999, 9999):			
Input	Range	Readout	Limit
All	All	-1999	Display readout <-1999
		9999	Display readout >9999

Sensor error detection

Sensor error detection (SE.BR, SE.SH):			
Input	Range	Readout	Condition
CURR	Loop break (4...20 mA)	SE.BR	<= 3.6 mA; >= 21 mA
		SE.SH	Sensor shorted
POTM	All, SE.BR on all 3-wire	SE.BR	Sensor broken or wire resistance too high
		SE.SH	Sensor shorted
LIN.R	All	SE.BR	Sensor broken or wire resistance too high
	For Lin. R_0%≥ app. 18 Ω	SE.SH	Sensor shorted
TEMP	All	SE.BR	Sensor broken or wire resistance too high
		SE.SH	Sensor shorted
	Pt100 to Pt1000 and Ni50 to Ni1000	SE.SH	Sensor shorted

Hardware error

Readout at hardware error		
Error search	Readout	Cause
CJC sensor error - check device temperature	CJ.ER	Defect internal CJC sensor or CJC temperature out of allowed range **
CJC connector error - check CJC connector block	CJ.CE	Defect (or missing) CJC connector or temperature out of allowed range **
Input error - check input connection and reset power	IN.ER	Signal levels on input beyond limits or connected to wrong terminals*
Output error - check output connections and reset power	AO.ER	Error in analogue output current (SIL mode only)*
No communication	NO.CO	No communication with (4501)
Flash memory error - check configuration	FL.ER CO.ER	FLASH error (configuration invalid)***
Invalid configuration type or version	TY.ER	Configuration read from EEprom has invalid type or rev. no.
Hardware error	RA.ER	RAM error*
Hardware error	IF.ER	Internal Flash error*
Hardware error	SW.ER	SW monitor error*
Hardware error	AD.ER	A/D converter error*
Hardware error	AO.SU	Analogue output supply error*
Hardware error	CA.ER	Factory calibration error*
Hardware error	CM.ER	Main CPU error*
Hardware error	RE.ER	Relay readback error*
Hardware error	II.ER	Initialization check error*
Hardware error	RS.ER	Reset error*
Hardware error	IC.ER	Input communication error*
Hardware error	M1.ER	Main CPU to Ch.1 error*
Hardware error	MC.ER	Main CPU config. error*
Hardware error	MF.ER	Main CPU Flash error*
Hardware error	MR.ER	Main CPU Ram error*
Hardware error	MS.ER	Main CPU supply error*
Hardware error	MP.ER	Main CPU ProgFlow error*
Hardware error	MI.ER	Main CPU initialization check error*
Hardware error	DE.ER	Device error*
Hardware error	FC.ER	Invalid code checksum in 4501

- ! All error indications in the display flash once per second (1 Hz), and the corresponding help text is shown. If the error is a sensor error, the display backlight flashes as well - this is acknowledged (stopped) by pushing the OK button.
- * Error is acknowledged by resetting the device power
- ** Error can be disregarded by selecting input type different than TC.
- *** Error is acknowledged by stepping through the basic setup.

CONNECTIONS

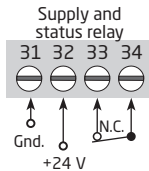
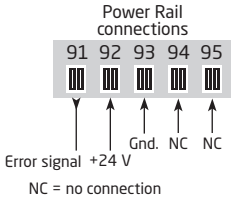

Inputs:

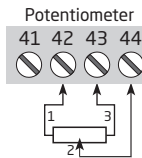
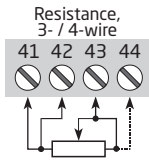
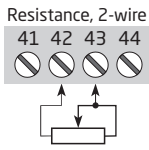
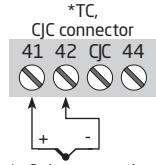
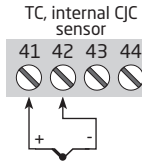
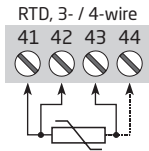
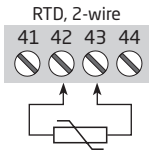

* TC, CJC connector
5910Ex.

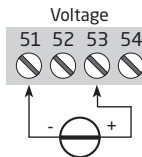
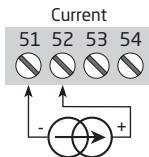
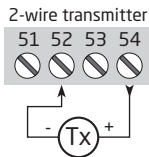

Outputs:

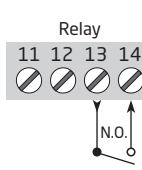
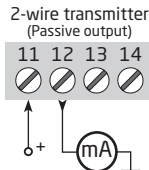
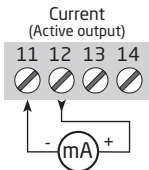

BLOCK DIAGRAM

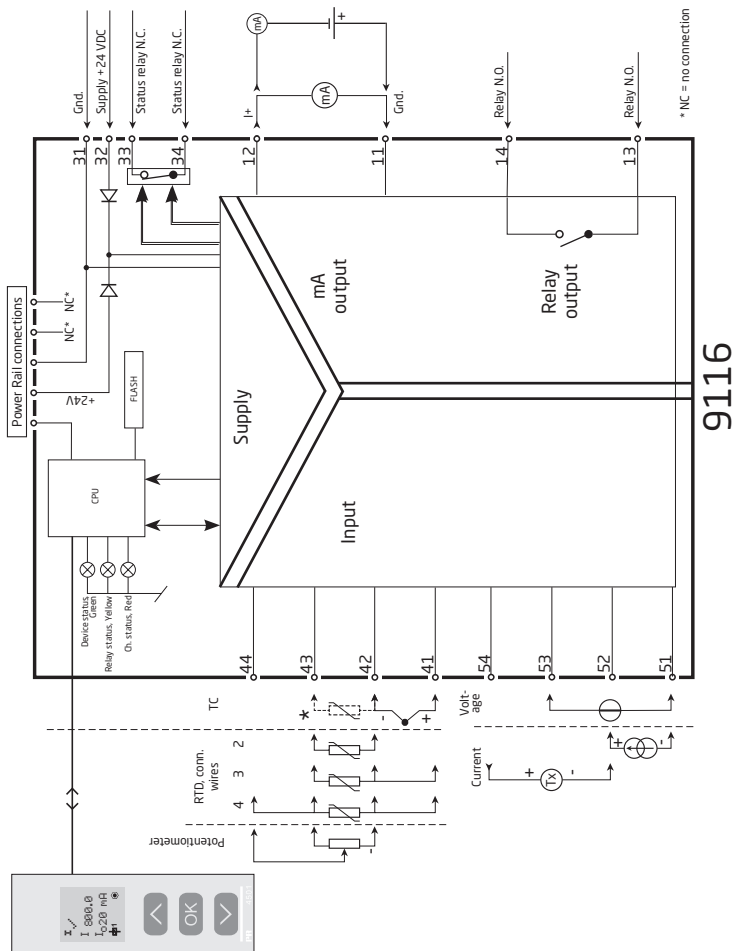

Signal error and cable fault indications without display front

List of LED and error signal indications					
Condition	Green LED	Relay: Yellow LED	Error: Red LED	Status relay, N.C.	Power rail signal status
No supply	OFF	OFF	OFF	De-energized	Closed
Device failure	OFF		ON	De-energized	Closed
Device OK	Flashing			Energized	Open
Signal OK	Flashing		OFF	Energized	Open
Output relay energized	Flashing	ON	OFF	Energized	Open
Output relay energized w. wire short/break	Flashing	ON	Flashing	De-energized	Closed (if enabled)
Output relay de-energized w. wire short/break	Flashing	OFF	Flashing	De-energized	Closed (if enabled)
Output relay de-energized	Flashing	OFF	OFF	Energized	Open

CONFIGURATION / OPERATING THE FUNCTION KEYS

Documentation for routing diagram.

In general

When configuring the 9116, you will be guided through all parameters and you can choose the settings which fit the application. For each menu there is a scrolling help text which is automatically shown in line 3 on the display.

Configuration is carried out by use of the 3 function keys:

- ⬆ will increase the numerical value or choose the next parameter
- ⬇ will decrease the numerical value or choose the previous parameter
- OK will accept the chosen value and proceed to the next menu

When configuration is completed, the display will return to the default state 1.0.

Pressing and holding OK will return to the previous menu or return to the default state (1.0) without saving the changed values or parameters.

If no key is activated for 1 minute, the display will return to the default state (1.0) without saving the changed values or parameters.

Further explanations

Password protection: Programming access can be blocked by assigning a password. The password is saved in the converter in order to ensure a high degree of protection against unauthorised modifications to the configuration. Default password 2008 allows access to all configuration menus. Password protection is mandatory in SIL applications.

Selection of units

After choosing the input signal type you can choose which process units should be shown in the display (see table). By selection of temperature input the process value is always displayed in Celsius or Fahrenheit. This is selected in the menu point after selection of temperature input.

CJC

In the CJC menu you can choose between CJC connector and internal cold junction compensation. The CJC connector (PR 5910Ex) must be ordered separately.

Signal and sensor error information via display front 4501

Sensor error (see limits in the table) is displayed as SE.BR (sensor break) or SE.SH (sensor short). Signals outside the selected range (not sensor error, see table for limits) are displayed as IN.LO indicating low input signal or IN.HI indicating high input signal. The error indication is displayed as text in line 1 and at the same time the backlight flashes. Line 4 of the display is a status line which shows whether the device is SIL-locked (static dot = SIL-locked and flashing dot = not SIL-locked) as well as relay status and COM (running circle) indicating correct functioning of 4501.

Signal and sensor error indication without display front

Status of the unit can also be read from the 3 LEDs in the front of the device.

Green flashing LED indicates normal operation.

No light in the green LED indicates lack of supply voltage or error in the device.

Steady red LED indicates fatal error.

Flashing red LED indicates sensor error.

Relay functions

5 different settings of relay function can be selected.

Setpoint: The unit works as a single trip amplifier

Window: The relay has a window that is defined by a low and a high setpoint. On both sides of the window the relay has the same status.

Error function: The relay is activated by sensor error.

Power: The relay is activated as long as the power is on.

Off: The relay is deactivated.

Increasing/decreasing: The relay can be set to activate at increasing or decreasing input signal.

Delay: An ON and an OFF delay can be set in the range 0...3600 s.

Hysteresis: A hysteresis can be set at 0.1...25% of the span or between 1 and 25% of display range.

Window: The window function is selected by choosing "window" in the menu and defining a high and a low setpoint.

See the graphic depiction of the window functions on page 31.

Setpoint: The setpoint function is selected by choosing "setpoint" in the menu and entering the desired limit. The device then works as a single limit switch.

See the graphic depiction of the window functions on page 32.

An activated relay means that the contact is closed if the contact function "normally open" is selected, and the contact is open if the contact function "normally closed" is selected.

The delay time for activation and deactivation can be set independently of each other in the menus ON.DEL and OFF DEL respectively.

Advanced functions

The unit gives access to a number of advanced functions which can be reached by answering "Yes" to the point "adv.set".

Display setup: Here you can adjust the brightness contrast and the backlight. Setup of TAG numbers with 5 alphanumerics. Input value is always shown in line 2. Selection of functional readout in line 3 of the display - choose between readout of analogue output or tag no or alternating display.

Two-point process calibration: The device can be process-calibrated in 2 points to fit a given input signal. A low input signal (not necessarily 0%) is applied and the actual value is entered via 4501. Then a high signal (not necessarily 100%) is applied and the actual value is entered via 4501. If you accept to use the calibration, the device will work according to this new adjustment. If you later reject this menu point or choose another type of input signal the device will return to factory calibration.

Process simulation function: In the menu point "EN.SIM" it is possible to simulate an input signal by means of the arrow keys and thus control the output signal up or down, or the relay state OFF and ON. You must exit the menu by pressing  (no time-out). The simulation function exits automatically, if the 4501 is detached.

Password: Here you can choose a pass word between 0000 and 9999 in order to protect the device against unauthorised modifications to the configuration. The device is delivered default without password.

Memory: In the memory menu you can save the configuration of the device in the 4501, and then move the 4501 onto another device of the same type and download the configuration in the new device.

Language: In the menu "lang.setup" you can choose between 7 different language versions of help texts that will appear in the menu. You can choose between UK, DE, FR, IT, ES, SE and DK.

Power rail: In the menu "RAIL" you can choose if sensor errors are transmitted to the central surveillance in the PR 9410 power control unit.

Safety integrity level: See Safety Manual for details



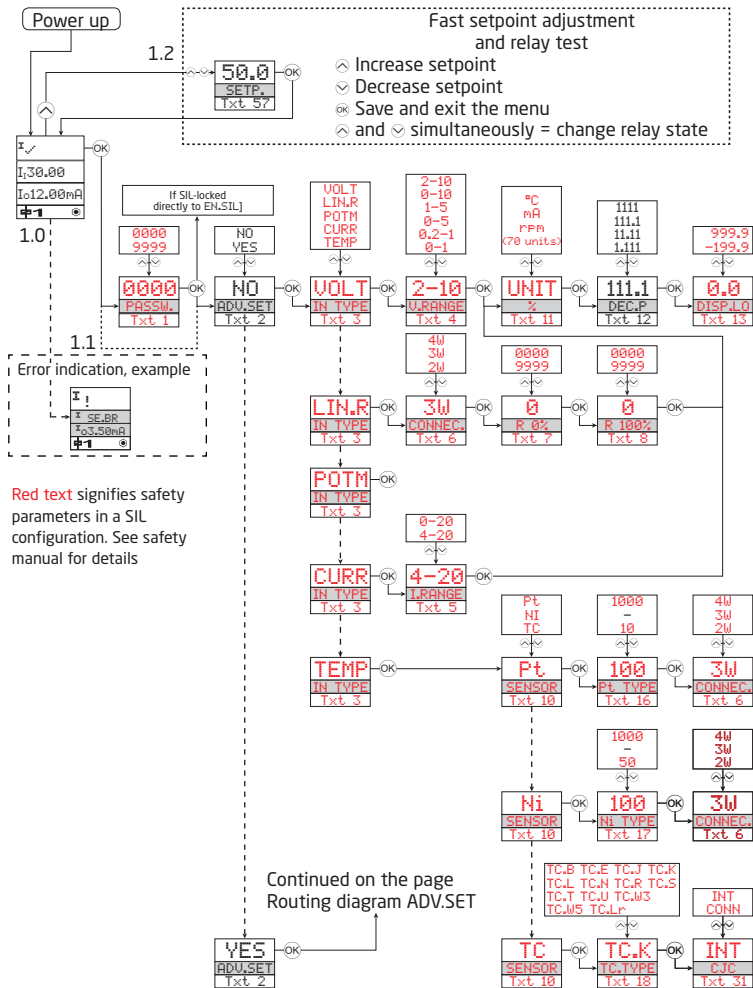

ROUTING DIAGRAM

If no key is activated for 1 minute, the display will return to the default state 1.0 without saving configuration changes.

- ⬆ Increase value / choose next parameter
- ⬇ Decrease value / choose previous parameter
- ⊗ Accept the chosen value and proceed to the next menu
- Hold ⏪ Back to previous menu / return to menu 1.0 without saving

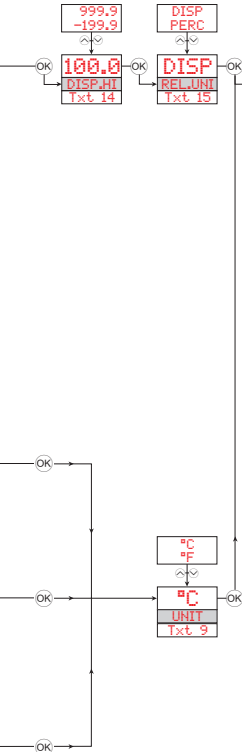

Continued on the next page

- 1.0 = Default state. Line 1 shows input status. Line 2 shows input value and TAG NO. Line 3 shows output value and units. Line 4 shows status for relay and communication and whether the device is SIL-locked. Static dot = SIL-locked and flashing dot = not SIL-locked.
- 1.1 = Only if password-protected.
- 1.2 = Only if FastSet is activated and the relay function is setpoint.
- 1.3 = Only if input types support sensor error check. Not valid for these input signals: 0...20 mA and voltage.
- 1.4 = Only if input signal is temperature.
- 1.5 = Only if the configuration is not protected by a password.

Selectable UNITS:

°C	s	rPM	MWh	ohm
°F	min	Hz	kWh	S
K	m/s	t	W	uS
%	mm/s	kg	GW	m ³ /min
m	m/min	g	MW	m ³ /h
cm	m/h	N	kW	l/s
mm	in/s	Pa	hp	l/min
um	ips	MPa	A	l/h
ft	ft/s	kPa	kA	gal/min
in	in/min	hPa	mA	gal/h
mils	ft/min	bar	uA	t/h
yd	in/h	mbar	V	mol
m ³	ft/h	kJ	kV	PH
l	m/s ²	Wh	mV	[blank]

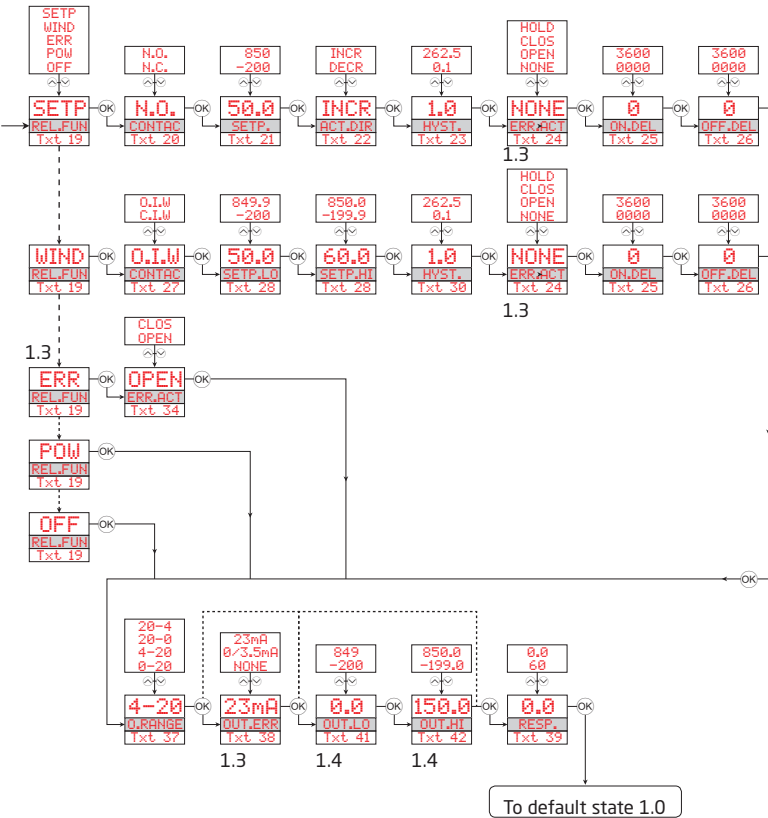

ROUTING DIAGRAM

ADVANCED SETTINGS (ADV.SET)

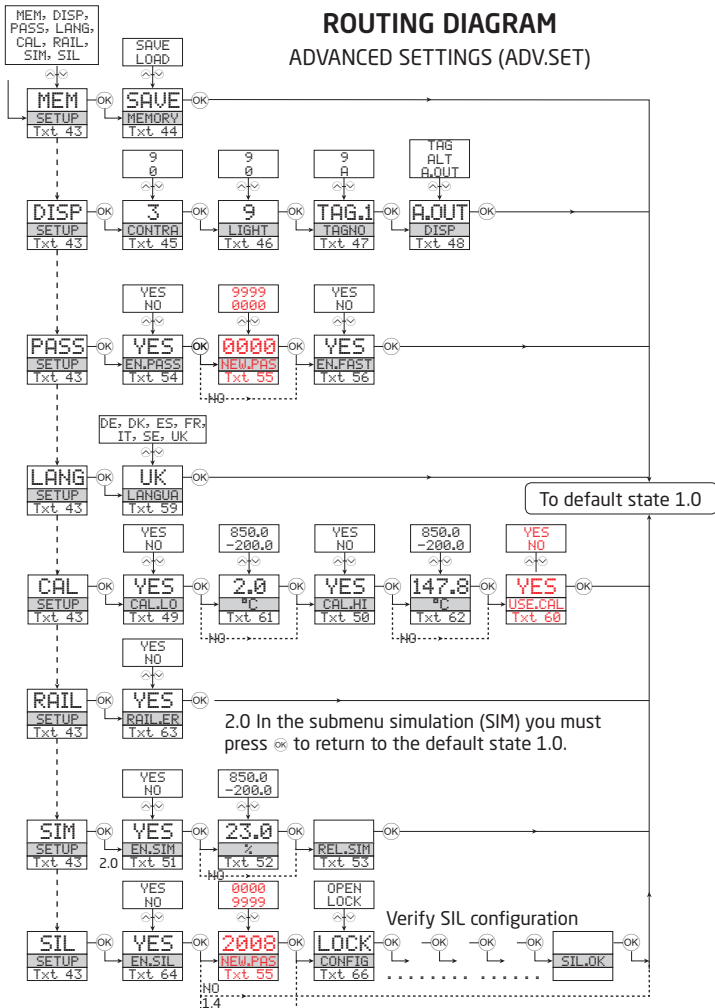

SCROLLING HELP TEXTS IN DISPLAY LINE 3

- [01] Set correct password
- [02] Enter Advanced setup menu?
- [03] Select Temperature input
Select Potentiometer input
Select Linear resistance input
Select Current input
Select Voltage input
- [04] Select 0.0-1 V input range
Select 0.2-1 V input range
Select 0-5 V input range
Select 1-5 V input range
Select 0-10 V input range
Select 2-10 V input range
- [05] Select 0-20 mA input range
Select 4-20 mA input range
- [06] Select 2-Wire sensor connection
Select 3-Wire sensor connection
Select 4-Wire sensor connection
- [07] Set Resistance value low
- [08] Set Resistance value high
- [09] Select Celsius as temperature unit
Select Fahrenheit as temperature unit
- [10] Select TC sensor type
Select Ni sensor type
Select Pt sensor type
- [11] Select Display unit
- [12] Select Decimal point position
- [13] Set Display range low
- [14] Set Display range high
- [15] Select Relay setpoint in % of input range
Select Relay setpoint in display units
- [16] Select Pt10 sensor type
Select Pt20 sensor type
Select Pt50 sensor type
Select Pt100 sensor type
Select Pt200 sensor type
Select Pt250 sensor type
Select Pt300 sensor type
Select Pt400 sensor type
Select Pt500 sensor type
Select Pt1000 sensor type
- [17] Select Ni50 sensor type
Select Ni100 sensor type
Select Ni120 sensor type
Select Ni1000 sensor type
- [18] Select TC-B sensor type
Select TC-E sensor type
Select TC-J sensor type
Select TC-K sensor type
Select TC-L sensor type
Select TC-N sensor type
Select TC-R sensor type
Select TC-S sensor type
Select TC-T sensor type
Select TC-U sensor type
Select TC-W3 sensor type
Select TC-W5 sensor type
Select TC-Lr sensor type
- [19] Select OFF function - relay is permanently off
Select POWER function - relay indicates power status OK
Select ERROR function - relay indicates sensor error only
Select WINDOW function - relay is controlled by 2 setpoints
Select SETPOINT function - relay is controlled by 1 setpoint
- [20] Select Normally Closed contact
Select Normally Open contact
- [21] Set Relay setpoint
- [22] Select Action on decreasing signal
Select Action on increasing signal
- [23] Set Relay hysteresis
- [24] Select No error action - undefined status at error
Select Open relay contact at error
Select Close relay contact at error
Select Hold relay status at error
- [25] Set Relay ON delay in seconds
- [26] Set Relay OFF delay in seconds
- [27] Select Contact is Closed Inside Window
Select Contact is Open Inside Window
- [28] Set Relay window setpoint low
- [29] Set Relay window setpoint high
- [30] Set Relay window hysteresis
- [31] Select Internal temperature sensor
Select CJC connector (Accessory)
- [34] Select Open relay contact at error
Select Close relay contact at error
- [37] Select 0-20 mA output range
Select 4-20 mA output range
Select 20-0 mA output range
Select 20-4 mA output range
- [38] Select No error action - output undefined at error
Select Downscale at error
Select Namur NE43 downscale at error
Select Namur NE43 upscale at error
- [39] Select Analogue output response time in seconds.
- [41] Set Temperature for analogue output low
- [42] Set Temperature for analogue output high
- [43] Enter SIL setup
Enter Simulation mode
Enter Rail setup
Perform Process Calibration
Enter Language setup
Enter Password setup
Enter Display setup
Perform Memory operations
- [44] Load saved configuration into module
Save configuration in display front
- [45] Adjust LCD contrast
- [46] Adjust LCD backlight
- [47] Write a 5-character channel TAG
- [48] Show Analog output value in display
Show TAG on display
Alternate shown information in display
- [49] Calibrate input low to process value?
- [50] Calibrate input high to process value?
- [51] Enable input simulation?
- [52] Set the input simulation value
- [53] Relay simulation - use \leftarrow to toggle relay
- [54] Enable Password protection?
- [55] Set New password
- [56] Enable Fastset functionality?
- [57] Relay setpoint - press \leftarrow to save
- [58] Relay setpoint - Read only
- [59] Select Language
- [60] Use process calibration values?
- [61] Set value for low calibration point
- [62] Set value for high calibration point
- [63] Enable Rail status signal output?
- [64] Enable SIL configuration lock?
0...20 mA is not a valid output range for SIL operation

- [65] Is channel using process-compensated calibration data?
- [66] Configuration SIL status (Open / Locked)
- [80] Sensor short circuit
- [81] Sensor wire breakage
- [82] Display underrange
- [83] Display overrange
- [84] Input underrange
- [85] Input overrange
- [86] Input error - check input connections and reset power
- [87] Output error - check connections and reset power
- [88] Flash memory error - check configuration
- [89] Invalid configuration type or version
- [90] Hardware error
- [91] CJC sensor error - check device temperature
- [92] CJC error - check CJC connector block
- [93] No communication

Graphic depiction of window

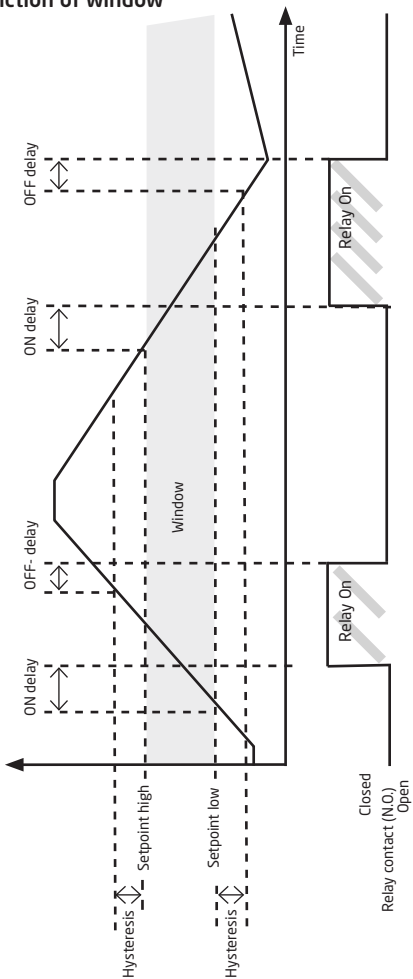

Graphic depiction of setpoint

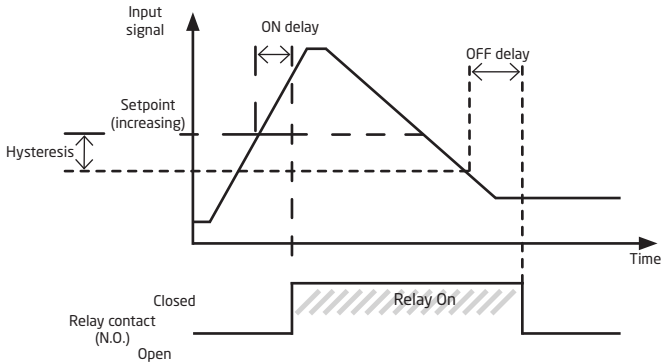

APPENDIX

IECEX Installation drawing
ATEX Installation drawing
FM Installation drawing
INMETRO Installation drawing

Safety manual

LERBAKKEN 10, 8410 ROENDE DENMARK

IECEx Installation drawing

9116

For safe installation of 9116B the following must be observed. The module shall only be installed by qualified personnel who are familiar with the national and international laws, directives and standards that apply to this area.



Year of manufacture can be taken from the first two digits in the serial number.

4501

For installation in Zone 2 the following must be observed.

The 4501 programming module is to be used solely with PR electronics modules. It is important that the module is undamaged and has not been altered or modified in any way. Only 4501 modules free of dust and moisture shall be installed.



IECEx Certificate:KEM 10.0022X

Marking: [Ex ia Ga] IIC/IIB/IIA
 [Ex nA nC IIC T4 Gc]
 [Ex ia Da] IIIC
 [Ex ia Ma] I

Standards

IEC60079-15:2005, IEC60079-11:2011, IEC60079-0:2011
 IEC60079-26:2006

Hazardous area
 Zone 0, 1, 2, 20, 21 and 22

Non Hazardous area
 or Zone 2

$-20 \leq T_a \leq +60^{\circ}\text{C}$

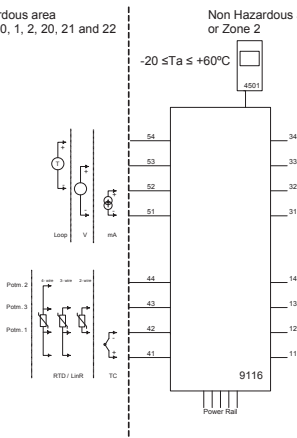
Status relay, terminal (33,34)
Non hazardous area installation

Voltage max: 125 VAC / 110 VDC
 Power max: 62.5 VA / 32 W
 Current max: 0.5 A AC / 0.3 ADC

Zone 2 installation:

Voltage max: 32 VAC / 32 VDC
 Power max: 16 VA / 32 W
 Current max: 0.5 A AC / 1 A DC

Relay output, terminal (13,14)
Non hazardous area installation

Voltage max: 250 VAC / 30 VDC
 Power max: 500 VA / 60 W
 Current max: 2 A AC / 2 ADC

Zone 2 installation

Voltage max: 32 VAC / 30 VDC
 Power max: 64 VA / 60 W
 Current max: 2 A AC / 2 ADC

(terminal 11,12,13,14)
 (terminal 31,32,33,34)
 (terminal 91,92,93,94,95)
 U_m : 253 V; max. 400 Hz

Revision date:
 2012-07-04

Version Revision
 V6 R0

Prepared by:
 PB

Page:
 1/4

LERBAKKEN 10, 8410 ROENDE DENMARK

Module 9116B1	
Terminal 51-52, 51-53	
Ui	30 V
Ii	120 mA
Pi	900 mW
Ci	3 nF
Li	1 µH

Module 9116B2	
Terminal 51-52, 51-53	
Ui	30 V
Ii	120 mA
Pi	900 mW
Ci	3 nF
Li	1 µH

Module 9116B1		Group	Co	Lo	Lo/Ro
Terminal 51-54, 52-54					
Uo	28 V	IIC	80 nF	4 mH	54 µH/Q
Io	93 mA	IIB	640 nF	16 mH	218 µH/Q
Po	650 mW	IIA	2.1 µF	32 mH	436 µH/Q

Module 9116B2		Group	Co	Lo	Lo/Ro
Terminal 51-54, 52-54					
Uo	21.4 V	IIC	0.16 µF	4 mH	54 µH/Q
Io	93 mA	IIB	1.13 µF	16 mH	218 µH/Q
Po	650 mW	IIA	4.15 µF	32 mH	436 µH/Q

Module 9116B1		Group	Co	Lo	Lo/Ro
Terminal 51-53					
Uo	28 V	IIC	80 nF	1000 mH	4 mH/Q
Io	1.1 mA	IIB	640 nF	1000 mH	17 mH/Q
Po	8 mW	IIA	2.1 µF	1000 mH	35 mH/Q

Module 9116B2		Group	Co	Lo	Lo/Ro
Terminal 51-53					
Uo	21.4 V	IIC	0.16 µF	1000 mH	4 mH/Q
Io	1.1 mA	IIB	1.13 µF	1000 mH	17 mH/Q
Po	8 mW	IIA	4.15 µF	1000 mH	35 mH/Q

Module 9116B1		Group	Co	Lo	Lo/Ro
Terminal 51-52					
Uo	8.3 V	IIC	7 µF	1000 mH	100 mH/Q
Io	0.2 mA	IIB	73 µF	1000 mH	400 mH/Q
Po	0.4 mW	IIA	1000 µF	1000 mH	800 mH/Q

Module 9116B2		Group	Co	Lo	Lo/Ro
Terminal 51-52					
Uo	8.3 V	IIC	7 µF	1000 mH	100 mH/Q
Io	0.2 mA	IIB	73 µF	1000 mH	400 mH/Q
Po	0.4 mW	IIA	1000 µF	1000 mH	800 mH/Q

Module 9116B1		Group	Co	Lo	Lo/Ro
Terminal 41,42,43,44					
Uo	8.3 V	IIC	7 µF	207 mH	1 mH/Q
Io	13.1 mA	IIB	73 µF	828 mH	5 mH/Q
Po	27.3 mW	IIA	1000 µF	1000 mH	10 mH/Q

Module 9116B2		Group	Co	Lo	Lo/Ro
Terminal 41,42,43,44					
Uo	8.3 V	IIC	7 µF	207 mH	1 mH/Q
Io	13.1 mA	IIB	73 µF	828 mH	5 mH/Q
Po	27.3 mW	IIA	1000 µF	1000 mH	10 mH/Q

Installation notes:

For group I (mines), the parameters for group IIA apply.

Install in pollution degree 2, overvoltage category II as defined in IEC60664-1

Do not separate connectors when energized and an explosive gas mixture is present.

Do not mount or remove modules from the Power Rail when an explosive gas mixture is present.

Disconnect power before servicing.

The wiring of unused terminals is not allowed.

In type of protection [Ex ia Da] the parameters for intrinsic safety for gas group IIB are applicable.

For installation in Zone 2, the module shall be installed in an enclosure in type of protection Ex n or Ex e, providing a degree of protection of at least IP54. Cable entry devices and blanking elements shall fulfill the same requirements.

For installation on Power Rail in Zone 2, only Power Rail type 9400 supplied by Power Control Unit type 9410 (Type Examination Certificate KEMA 07ATEX0152 X) is allowed.

LERBAKKEN 10, 8410 ROENDE DENMARK

 Hazardous area
 Zone 0,1,2, 20, 21, 22

 Non Hazardous area
 of Zone 2

 $-20 \leq T_a \leq +60^{\circ}\text{C}$

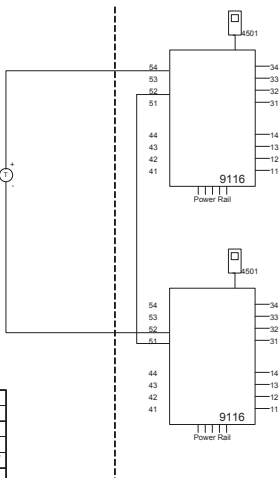
 4-20 mA
 Loop-powered
 transmitter

Status relay, terminal (33,34)
Non hazardous area installation
 Voltage max: 125 VAC / 110 VDC
 Power max: 62.5 VA / 32 W
 Current max: 0.5 A AC / 0.3 ADC

Zone 2 installation:
 Voltage max: 32 VAC / 32 VDC
 Power max: 16 VA / 32 W
 Current max: 0.5 A AC / 1 A DC

Relay output, terminal (13,14)
Non hazardous area installation
 Voltage max: 250 VAC / 30 VDC
 Power max: 500 VA / 60 W
 Current max: 2 A AC / 2A DC

Zone 2 installation
 Voltage max: 32 V AC / 30 VDC
 Power max: 64 VA / 60 W
 Current max: 2 A AC / 2 ADC

(terminal 11,12,13,14)
(terminal 31,32,33,34)
(terminal 91,92,93,94,95)
 $U_{m, 253\text{ V max. } 400\text{ Hz}}$

Module 9116B 1/2	
Terminal 54-52	
U _i	30 V
I _i	120 mA
P _i	900 mW
C _i	3 nF
L _i	2 μH

Module 9116B1					
Term. 54-52; 51-52		Group	Co	Lo	Lo/Ro
U _o	28 V	IIC	80 nF	4 mH	54 μH/Ω
I _o	93 mA	IIB	640 nF	16 mH	218 μH/Ω
P _o	650 mW	IIA	2.1 μF	32 mH	436 μH/Ω

Module 9116B2					
Term. 54-52; 51-52		Group	Co	Lo	Lo/Ro
U _o	21.4 V	IIC	0.16 μF	4 mH	54 μH/Ω
I _o	93 mA	IIB	1.13 μF	16 mH	218 μH/Ω
P _o	650 mW	IIA	4.15 μF	32 mH	436 μH/Ω

 Revision date:
 2012-07-04

 Version Revision
 V6 R0

 Prepared by:
 PB

 Page:
 3/4

LERBAKKEN 10, 8410 ROENDE DENMARK

 Hazardous area
 Zone 0, 1, 2, 20, 21, 22

 Non Hazardous area
 or Zone 2

 $-20 \leq T_a \leq +60^{\circ}\text{C}$

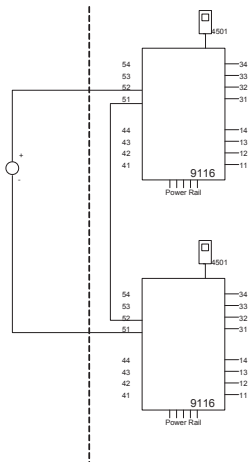
 0/4-20 mA
 Current source

Status relay, terminal (33,34)
Non hazardous area installation
 Voltage max: 125 VAC / 110 VDC
 Power max: 62.5 VA / 32 W
 Current max: 0.5 A AC / 0.3 ADC

Zone 2 installation:
 Voltage max: 32 VAC / 32 VDC
 Power max: 16 VA / 32 W
 Current max: 0.5 A AC / 1 A DC

Relay output, terminal (13,14)
Non hazardous area installation
 Voltage max: 250VAC / 30VDC
 Power max: 500VA / 60W
 Current max: 2A AC / 2ADC

Zone 2 installation
 Voltage max: 32 VAC / 30 VDC
 Power max: 64 VA / 60 W
 Current max: 2 A AC / 2 ADC

(terminal 11,12,13,14)
(terminal 31,32,33,34)
(terminal 91,92,93,94,95)
 $U_m: 253 \text{ V max. } 400 \text{ Hz}$

Module 9116B 1/2	
Terminal 51-52	
U _i	30 V
I _i	120 mA
P _i	900 mW
C _i	3 nF
L _i	2 μH

Module 9116B 1/2				
Term. 52-51, 51-52				
	Group	Co	Lo	Lo/Ro
U _o	IIC	0.4 μF	100 mH	25mH/Ω
I _o	IIB	2.3 μF	100 mH	100mH/Ω
P _o	IIA	9.5 μF	100 mH	200mH/Ω

 Revision date:
 2012-07-04

 Version Revision
 V6 R0

 Prepared by:
 PB

 Page:
 4/4

LERBAKKEN 10, 8410 ROENDE DENMARK

ATEX Installation drawing

9116

For safe installation of 9116B the following must be observed. The module shall only be installed by qualified personnel who are familiar with the national and international laws, directives and standards that apply to this area.

Year of manufacture can be taken from the first two digits in the serial number.

4501

For installation in Zone 2 the following must be observed.

The 4501 programming module is to be used solely with PR electronics' modules. It is important that the module is undamaged and has not been altered or modified in any way.

Only 4501 modules free of dust and moisture shall be installed.



ATEX Certificate:KEMA 10 ATEX 0053 X

Marking:



II (1) G [Ex ia Ga] IIC/IIB/IIA
 II 3 G Ex nA nC IIC T4 Gc
 II (1) D [Ex ia Da] IIIC
 I (M1) [Ex ia Ma] I

Standards

EN 60079-0 : 2009, EN 60079-11 : 2012, EN 60079-15 : 2005
 EN 60079-26 : 2007

Hazardous area
 Zone 0,1,2, 20, 21, 22

Non Hazardous area
 or Zone 2

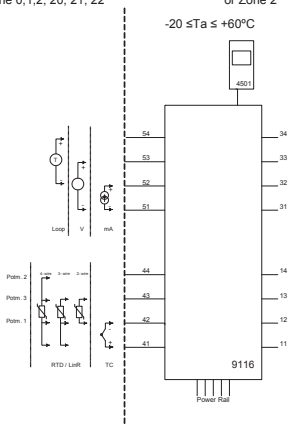
Status relay, terminal (33,34)
Non hazardous area installation

Voltage max: 125 VAC / 110 VDC
 Power max: 62.5 VA / 32 W
 Current max: 0.5 A AC / 0.3 ADC

Zone 2 installation:

Voltage max: 32 VAC / 32 VDC
 Power max: 16 VA / 32 W
 Current max: 0.5 A AC / 1 A DC

Relay output, terminal (13,14)
Non hazardous area installation

Voltage max: 250 VAC / 30 VDC
 Power max: 500 VA / 60 W
 Current max: 2 A AC / 2 ADC

Zone 2 installation

Voltage max: 32 VAC / 30 VDC
 Power max: 64 VA / 60 W
 Current max: 2 A AC / 2 ADC

(terminal 11,12,13,14)
(terminal 31,32,33,34)
(terminal 91,92,93,94,95)
 U_m: 253 V; max 400 Hz

Revision date:
 2012-07-04

Version Revision
 V6 R0

Prepared by:
 PB

Page:
 1/4

LERBAKKEN 10, 8410 ROENDE DENMARK

Module 9116B1	
Terminal 51-52, 51-53	
U _i	30 V
I _i	120 mA
P _i	900 mW
C _i	3 nF
L _i	1 µH

Module 9116B2	
Terminal 51-52, 51-53	
U _i	30 V
I _i	120 mA
P _i	900 mW
C _i	3 nF
L _i	1 µH

Module 9116B1		Group	Co	Lo	Lo/Ro
Terminal 51-54, 52-54					
U _o	28 V	IIC	80 nF	4 mH	54 µH/Q
I _o	93 mA	IIB	640 nF	16 mH	218 µH/Q
P _o	650 mW	IIA	2.1 µF	32 mH	436 µH/Q

Module 9116B2		Group	Co	Lo	Lo/Ro
Terminal 51-54, 52-54					
U _o	21.4 V	IIC	0.16 µF	4 mH	54 µH/Q
I _o	93 mA	IIB	1.13 µF	16 mH	218 µH/Q
P _o	650 mW	IIA	4.15 µF	32 mH	436 µH/Q

Module 9116B1		Group	Co	Lo	Lo/Ro
Terminal 51-53					
U _o	28 V	IIC	80 nF	1000 mH	4 mH/Q
I _o	1.1 mA	IIB	640 nF	1000 mH	17 mH/Q
P _o	8 mW	IIA	2.1 µF	1000 mH	35 mH/Q

Module 9116B2		Group	Co	Lo	Lo/Ro
Terminal 51-53					
U _o	21.4 V	IIC	0.16 µF	1000 mH	4 mH/Q
I _o	1.1 mA	IIB	1.13 µF	1000 mH	17 mH/Q
P _o	8 mW	IIA	4.15 µF	1000 mH	35 mH/Q

Module 9116B1		Group	Co	Lo	Lo/Ro
Terminal 51-52					
U _o	8.3 V	IIC	7 µF	1000 mH	100 mH/Q
I _o	0.2 mA	IIB	73 µF	1000 mH	400 mH/Q
P _o	0.4 mW	IIA	1000 µF	1000 mH	800 mH/Q

Module 9116B2		Group	Co	Lo	Lo/Ro
Terminal 51-52					
U _o	8.3 V	IIC	7 µF	1000 mH	100 mH/Q
I _o	0.2 mA	IIB	73 µF	1000 mH	400 mH/Q
P _o	0.4 mW	IIA	1000 µF	1000 mH	800 mH/Q

Module 9116B1		Group	Co	Lo	Lo/Ro
Terminal 41,42,43,44					
U _o	8.3 V	IIC	7 µF	207 mH	1 mH/Q
I _o	13.1 mA	IIB	73 µF	828 mH	5 mH/Q
P _o	27.3 mW	IIA	1000 µF	1000 mH	10 mH/Q

Module 9116B2		Group	Co	Lo	Lo/Ro
Terminal 41,42,43,44					
U _o	8.3 V	IIC	7 µF	207 mH	1 mH/Q
I _o	13.1 mA	IIB	73 µF	828 mH	5 mH/Q
P _o	27.3 mW	IIA	1000 µF	1000 mH	10 mH/Q

Installation notes:

For group I (mines), the parameters for group IIA apply.

Install in pollution degree 2, overvoltage category II as defined in EN60664-1

Do not separate connectors when energized and an explosive gas mixture is present.
Do not mount or remove modules from the Power Rail when an explosive gas mixture is present.
Disconnect power before servicing.
The wiring of unused terminals is not allowed.

In type of protection [Ex ia Da] the parameters for intrinsic safety for gas group IIB are applicable.

For installation in Zone 2, the module shall be installed in an enclosure in type of protection Ex n or Ex e, providing a degree of protection of at least IP54. Cable entry devices and blanking elements shall fulfill the same requirements.

For installation on Power Rail in Zone 2, only Power Rail type 9400 supplied by Power Control Unit type 9410 (Type Examination Certificate KEMA 07ATEX0152 X) is allowed.

LERBAKKEN 10, 8410 ROENDE DENMARK

 Hazardous area
 Zone 0, 1, 2, 20, 21, 22

 Non Hazardous area
 or Zone 2

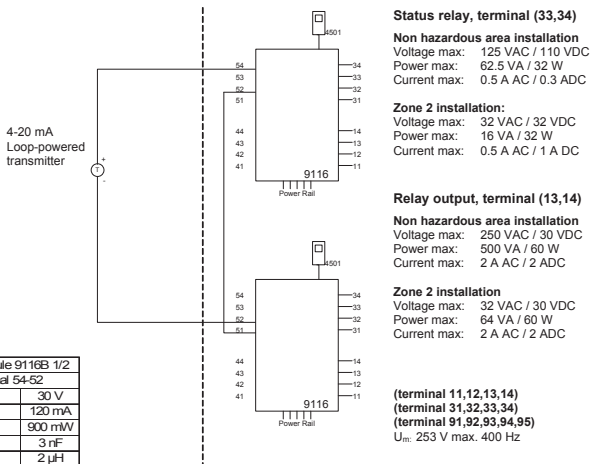
 $-20\text{ }^{\circ}\text{C} \leq T_a \leq +60\text{ }^{\circ}\text{C}$

Module 9116B 1/2	
Terminal 54-52	
U _i	30 V
I _i	120 mA
P _i	900 mW
C _i	3 nF
L _i	2 μH

Module 9116B1		Group	Co	Lo	Lo/Ro
Term. 54-52; 51-52					
U _o	28 V	IIC	80 nF	4 mH	54 μH/Ω
I _o	93 mA	IIB	640 nF	16 mH	218 μH/Ω
P _o	650 mW	IIA	2.1 μF	32 mH	436 μH/Ω

Module 9116B2		Group	Co	Lo	Lo/Ro
Term. 54-52; 51-52					
U _o	21.4 V	IIC	0.16 μF	4 mH	54 μH/Ω
I _o	93 mA	IIB	1.13 μF	16 mH	218 μH/Ω
P _o	650 mW	IIA	4.15 μF	32 mH	436 μH/Ω

 Revision date:
 2012-07-04

 Version Revision
 V6 R0

 Prepared by:
 PB

 Page:
 3/4

LERBAKKEN 10, 8410 ROENDE DENMARK

 Hazardous area
 Zone 0, 1, 2, 20, 21, 22

 Non Hazardous area
 or Zone 2

 $-20\text{ }^{\circ}\text{C} \leq T_a \leq +60\text{ }^{\circ}\text{C}$

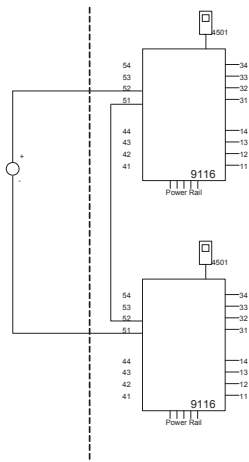
 0/4-20 mA
 Current source

Status relay, terminal (33,34)
Non hazardous area installation
 Voltage max: 125 VAC / 110 VDC
 Power max: 62.5 VA / 32 W
 Current max: 0.5 A AC / 0.3 ADC

Zone 2 installation:
 Voltage max: 32 VAC / 32 VDC
 Power max: 16 VA / 32 W
 Current max: 0.5 A AC / 1 A DC

Relay output, terminal (13,14)
Non hazardous area installation
 Voltage max: 250 VAC / 30 VDC
 Power max: 500 VA / 60 W
 Current max: 2 A AC / 2 ADC

Zone 2 installation
 Voltage max: 32 VAC / 30 VDC
 Power max: 64 VA / 60 W
 Current max: 2 A AC / 2 ADC

(terminal 11,12,13,14)
(terminal 31,32,33,34)
(terminal 91,92,93,94,95)
 U_m : 253 V max. 400 Hz

Module 9116B 1/2	
Terminal 51-52	
U _i	30 V
I _i	120 mA
P _i	900 mW
C _i	3 nF
L _i	2 μH

Module 9116B 1/2					
Term. 52-51, 51-52		Group	Co	Lo	Lo/Ro
U _o	16.6 V	IIC	0.4 μF	100 mH	25mH/Ω
I _o	0.2 mA	IIB	2.3 μF	100 mH	100mH/Ω
P _o	0.8 mW	IIA	9.5 μF	100 mH	200mH/Ω

 Revision date:
 2012-07-04

 Version Revision
 V6 R0

 Prepared by:
 PB

 Page:
 4/4

LERBAKKEN 10, 8410 ROENDE DENMARK

FM Installation drawing

9116

For safe installation of 9116B the following must be observed. The module shall only be installed by qualified personnel who are familiar with the national and international laws, directives and standards that apply to this area.



Year of manufacture can be taken from the first two digits in the serial number.

4501

For installation in Zone 2 / Division 2 the following must be observed.

The 4501 programming module is to be used solely with PR electronics modules. It is important that the module is undamaged and has not been altered or modified in any way. Only 4501 modules free of dust and moisture shall be installed.



c-FM-us Certificate 3038267

Hazardous Classified Location

Class I/II/III, Division 1, Group A,B,C,D,E,F,G
or Class I, Zone 0/1 Group IIC, [AEx ia] IIC
or Class I, Zone 0/1 Group IIC, [Ex ia] IIC

**Unclassified Location or
Hazardous Classified Location**

Class I, Division 2 Group A,B,C,D T4
or Class I, Zone 2, Group IIC T4

Simple Apparatus or
Intrinsic safe apparatus
with entity parameters:

$V_{max}(I_i) \geq V_t(U_o)$
 $I_{max}(I_i) \geq I_t(I_o)$
 $P_i \geq P_t(P_o)$
 $C_a \geq C_{cable} + C_i$
 $L_a \geq L_{cable} + L_i$

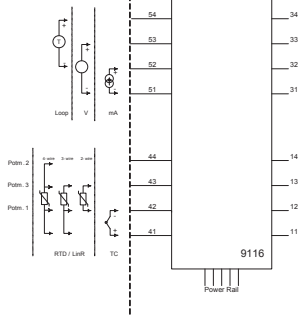
 $-20 \leq T_a \leq +60^\circ\text{C}$

Status relay, terminal (33,34)
Non hazardous area installation

Voltage max: 125 VAC / 110 VDC
Power max: 62.5 VA / 32 W
Current max: 0.5 A AC / 0.3 ADC

Zone 2 installation:

Voltage max: 32 VAC / 32 VDC
Power max: 16 VA / 32 W
Current max: 0.5 A AC / 1 A DC

Relay output, terminal (13,14)
Non hazardous area installation

Voltage max: 250 VAC / 30 VDC
Power max: 500 VA / 60 W
Current max: 2 A AC / 2 ADC

Zone 2 installation

Voltage max: 32 VAC / 30 VDC
Power max: 64 VA / 60 W
Current max: 2 A AC / 2 ADC

(terminal 11,12,13,14)
(terminal 31,32,33,34)
(terminal 91,92,93,94,95)
 U_m : 253 V max. 400 Hz

Revision date:
2012-06-08

Version Revision
V6 R0

Prepared by:
PB

Page:
1/4

LERBAKKEN 10, 8410 ROENDE DENMARK

Module 9116B1	
Terminal	51-52, 51-53
U _i , V _{max}	30 V
I _i , I _{max}	120 mA
P _i	900 mW
C _i	3 nF
L _i	1 µH

Module 9116B2	
Terminal	51-52, 51-53
U _i , V _{max}	30 V
I _i , I _{max}	120 mA
P _i	900 mW
C _i	3 nF
L _i	1 µH

Module 9116B1	Terminal 51-54, 52-54	Group	Co	Lo	Lo/Ro
U _o , V _{oc}	28 V	IIC or AB	80 nF	4 mH	54 µH/Q
I _o , I _{sc}	93 mA	IIB or C.E.F	640 nF	16 mH	218 µH/Q
P _o	650 mW	IIA or D.G	2.1 µF	32 mH	436 µH/Q

Module 9116B2	Terminal 51-54, 52-54	Group	Co	Lo	Lo/Ro
U _o , V _{oc}	21.4 V	IIC or AB	0.16 µF	4 mH	54 µH/Q
I _o , I _{sc}	93 mA	IIB or C.E.F	1.13 µF	16 mH	218 µH/Q
P _o	650 mW	IIA or D.G	4.15 µF	32 mH	436 µH/Q

Module 9116B1	Terminal 51-53	Group	Co	Lo	Lo/Ro
U _o , V _{oc}	28 V	IIC or AB	80 nF	1000 mH	4 mH/Q
I _o , I _{sc}	1.1 mA	IIB or C.E.F	640 nF	1000 mH	17 mH/Q
P _o	8 mW	IIA or D.G	2.1 µF	1000 mH	35 mH/Q

Module 9116B2	Terminal 51-53	Group	Co	Lo	Lo/Ro
U _o , V _{oc}	21.4 V	IIC or AB	0.16 µF	1000 mH	4 mH/Q
I _o , I _{sc}	1.1 mA	IIB or C.E.F	1.13 µF	1000 mH	17 mH/Q
P _o	8 mW	IIA or D.G	4.15 µF	1000 mH	35 mH/Q

Module 9116B1	Terminal 51-52	Group	Co	Lo	Lo/Ro
U _o , V _{oc}	8.3 V	IIC or AB	7 µF	1000 mH	100 mH/Q
I _o , I _{sc}	0.2 mA	IIB or C.E.F	73 µF	1000 mH	400 mH/Q
P _o	0.4 mW	IIA or D.G	1000 µF	1000 mH	800 mH/Q

Module 9116B2	Terminal 51-52	Group	Co	Lo	Lo/Ro
U _o , V _{oc}	8.3 V	IIC or AB	7 µF	1000 mH	100 mH/Q
I _o , I _{sc}	0.2 mA	IIB or C.E.F	73 µF	1000 mH	400 mH/Q
P _o	0.4 mW	IIA or D.G	1000 µF	1000 mH	800 mH/Q

Module 9116B1	Terminal 41,42,43,44	Group	Co	Lo	Lo/Ro
U _o , V _{oc}	8.3 V	IIC or AB	7 µF	207 mH	1 mH/Q
I _o , I _{sc}	13.1 mA	IIB or C.E.F	73 µF	828 mH	5 mH/Q
P _o	27.3 mW	IIA or D.G	1000 µF	1000 mH	10 mH/Q

Module 9116B2	Terminal 41,42,43,44	Group	Co	Lo	Lo/Ro
U _o , V _{oc}	8.3 V	IIC or AB	7 µF	207 mH	1 mH/Q
I _o , I _{sc}	13.1 mA	IIB or C.E.F	73 µF	828 mH	5 mH/Q
P _o	27.3 mW	IIA or D.G	1000 µF	1000 mH	10 mH/Q

Installation notes:

The installation and wiring shall be in accordance with the Canadian Electrical Code for Canada and National Electrical Code NFPA 70, Article 500 or 505 for installation in USA.

The module must be supplied from a Power Supply having double or reinforced insulation.

The use of stranded wires is not permitted for mains wiring except when wires are fitted with cable ends.

For installation on the 9400 Power Rail the power must be supplied from Power Control Module Unit 9410.

Install in pollution degree 2 or better, overvoltage category I or II.

The module must be installed in an enclosure suitable for the environment for which it is used.

In Class I, Division 2 /Zone 2 installations, the subject equipment shall be mounted within a tool-secured enclosure which is capable of accepting one or more of the Class I, Division 2 wiring methods specified in the National Electrical Code for USA or the Canadian Electrical Code for Canada

The module is galvanic isolated and does not require grounding.

Use 60 / 75 °C Copper Conductors with wire Size AWG: (26-14).

Warning: Substitution of components may impair intrinsic safety.

Warning: To prevent ignition of the explosive atmospheres, disconnect power before servicing and do not separate connectors when energized and an explosive gas mixture is present.

Warning: Do not mount or remove modules from the Power Rail when an explosive gas mixture is present.

LERBAKKEN 10, 8410 ROENDE DENMARK

Hazardous Classified Location

 Class I/II/III, Division 1, Group A,B,C,D,E,F,G
 or Class I, Zone 0/1 Group IIC, [AEx ia] IIC
 or Class I, Zone 0/1 Group IIC, [Ex ia] IIC

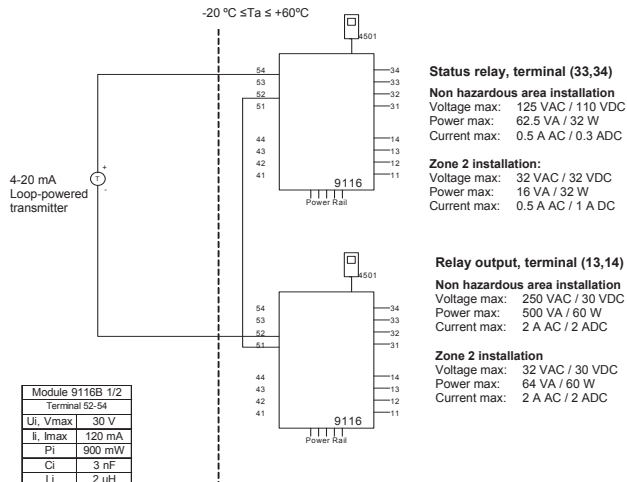
Unclassified Location or
Hazardous Classified Location
 Class I, Division 2 Group A,B,C,D T4
 or Class I, Zone 2, Group IIC T4

Module 9116B 1/2	
Terminal 52-54	
U _i , V _{max}	30 V
I _i , I _{max}	120 mA
P _i	900 mW
C _i	3 nF
L _i	2 μH

Module 9116B1	Group	C _o	L _o	Lo/Ro
U _o , V _{oc}	IIC or A,B	80 nF	4 mH	54 μH/Ω
I _o , I _{sc}	IIB or C,E,F	640 nF	16 mH	218 μH/Ω
P _o	IIA or D,G	2.1 μF	32 mH	436 μH/Ω

Module 9116B2	Group	C _o	L _o	Lo/Ro
U _o , V _{oc}	IIC or A,B	0.16 μF	4 mH	54 μH/Ω
I _o , I _{sc}	IIB or C,E,F	1.13 μF	16 mH	218 μH/Ω
P _o	IIA or D,G	4.15 μF	32 mH	436 μH/Ω

Status relay, terminal (33,34)
Non hazardous area installation

 Voltage max: 125 VAC / 110 VDC
 Power max: 62.5 VA / 32 W
 Current max: 0.5 A AC / 0.3 ADC

Zone 2 installation:

 Voltage max: 32 VAC / 32 VDC
 Power max: 16 VA / 32 W
 Current max: 0.5 A AC / 1 A DC

Relay output, terminal (13,14)
Non hazardous area installation

 Voltage max: 250 VAC / 30 VDC
 Power max: 500 VA / 60 W
 Current max: 2 A AC / 2 ADC

Zone 2 installation

 Voltage max: 32 VAC / 30 VDC
 Power max: 64 VA / 60 W
 Current max: 2 A AC / 2 ADC

(terminal 11,12,13,14)
 (terminal 31,32,33,34)
 (terminal 91,92,93,94,95)
 U_m: 253 V max. 400 Hz

LERBAKKEN 10, 8410 ROENDE DENMARK

Hazardous Classified Location

 Class I/II/III, Division 1, Group A,B,C,D,E,F,G
 or Class I, Zone 0/1 Group IIC, [AEx ia] IIC
 or Class I, Zone 0/1 Group IIC, [Ex ia] IIC

Unclassified Location or
Hazardous Classified Location
 Class I, Division 2 Group A,B,C,D T4
 or Class I, Zone 2, Group IIC T4

 $-20\text{ }^{\circ}\text{C} \leq T_a \leq +60\text{ }^{\circ}\text{C}$

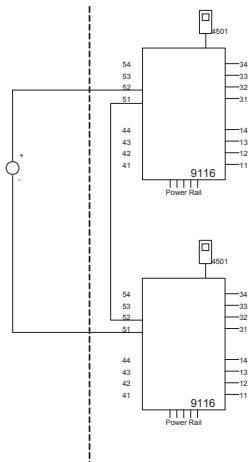
 0/4-20 mA
 Current Source

Status relay, terminal (33,34)
Unclassified location installation:

 Voltage max: 125 VAC / 110 VDC
 Power max: 62.5 VA / 32 W
 Current max: 0.5 A AC / 0.3 ADC

Zone 2 installation:

 Voltage max: 32 VAC / 30 VDC
 Power max: 16 VA / 32 W
 Current max: 0.5 A AC / 1 A DC

Relay output, terminal (13,14)
Unclassified location installation:

 Voltage max: 250 VAC / 30 VDC
 Power max: 500 VA / 60 W
 Current max: 2 A AC / 2 ADC

Zone 2 installation

 Voltage max: 32 VAC / 30 VDC
 Power max: 64 VA / 60 W
 Current max: 2 A AC / 2 ADC

(terminal 11,12,13,14)

(terminal 31,32,33,34)

(terminal 91,92,93,94,95)

 U_m : 253 V max. 400 Hz

Module 9116B 1/2	
Terminal 51-52	
Ui, Vmax	30 V
Ii, Imax	120 mA
Pi	900 mW
Ci	3 nF
Li	2 μ H

Module 9116B 1/2	Group	Co	Lo	Lo/Ro
Uo, Voc	IIC or A,B	0.4 μ F	100 mH	25mH/ Ω
Io, Isc	IIB or C,E,F	2.3 μ F	100 mH	100mH/ Ω
Po	IIA or D,G	9.5 μ F	100 mH	200mH/ Ω

 Revision date:
 2012-06-08

 Version Revision
 V6 R0

 Prepared by:
 PB

 Page:
 4/4

LERBAKKEN 10, 8410 ROENDE DENMARK

INMETRO Desenhos para Instalação



Para instalação segura do 9116B o manual seguinte deve ser observado. O módulo deve ser instalado somente por profissionais qualificados que estão familiarizados com as leis nacionais e internacionais, diretrizes e normas que se aplicam a esta área.

Ano de fabricação pode ser obtido a partir dos dois primeiros dígitos do número de série



4501

Para a instalação na Zona 2 o seguinte deve ser observado. O módulo de programação de 4501, deve ser utilizado apenas com os módulos PRelectronics. É importante que o módulo esteja intacto e não tenha sido alterado ou modificado de qualquer maneira.

Apenas os módulos 4501 livres de poeira e umidade devem ser instalados.

INMETRO Certificado NCC 12.1309X

Marcas:

[Ex ia Ga] IIC/IIB/IIA
Ex nA nC IIC T4 Gc
[Ex ia Da] IIIC

Normas

IEC60079-15:2005, IEC60079-11:2011, IEC60079-0:2011
IEC60079-26:2006

Área de Risco

Zona 0, 1, 2, 20, 21 e 22

Área de não Risco
ou Zona 2

-20 ≤ Ta ≤ +60°C

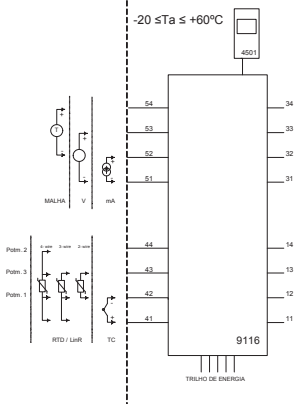

Relé de estado, terminais (33,34)

Instalação em área de não Risco

Voltagem máx.: 125 VAC / 110 VDC

Potência máx.: 62,5 VA / 32 W

Corrente máx.: 0,5 A AC / 0,3 ADC

Instalação em Zona 2:

Voltagem máx.: 32 VAC / 32 VDC

Potência máx.: 16 VA / 32 W

Corrente máx.: 0,5 A AC / 1 A DC

Relé de estado, terminais (13,14)

Instalação em área de não Risco

Voltagem máx.: 250 VAC / 30 VDC

Potência máx.: 500 VA / 60 W

Corrente máx.: 2 A AC / 2 ADC

Instalação em Zona 2:

Voltagem máx.: 32 VAC / 30 VDC

Potência máx.: 64 VA / 60 W

Corrente máx.: 2 A AC / 2 ADC

(terminais 11,12,13,14)

(terminais 31,32,33,34)

(terminais 91,92,93,94,95)

U_m: 253 V; máx. 400 Hz

Revision date:
2013-05-31

Version Revision
V6 R0

Prepared by:
PB

Page:
1/4

LERBAKKEN 10, 8410 ROENDE DENMARK

Module 9116B1	
Terminal 51-52, 51-53	
Ui	30 V
Ii	120 mA
Pi	900 mW
Ci	3 nF
Li	1 µH

Module 9116B2	
Terminal 51-52, 51-53	
Ui	30 V
Ii	120 mA
Pi	900 mW
Ci	3 nF
Li	1 µH

Module 9116B1		Group	Co	Lo	Lo/Ro
Terminal 51-54, 52-54					
Uo	28 V	IIC	80 nF	4 mH	54 µH/Q
Io	93 mA	IIB	640 nF	16 mH	218 µH/Q
Po	650 mW	IIA	2.1 µF	32 mH	436 µH/Q

Module 9116B2		Group	Co	Lo	Lo/Ro
Terminal 51-54, 52-54					
Uo	21.4 V	IIC	0.16 µF	4 mH	54 µH/Q
Io	93 mA	IIB	1.13 µF	16 mH	218 µH/Q
Po	650 mW	IIA	4.15 µF	32 mH	436 µH/Q

Module 9116B1		Group	Co	Lo	Lo/Ro
Terminal 51-53					
Uo	28 V	IIC	80 nF	1000 mH	4 mH/Q
Io	1.1 mA	IIB	640 nF	1000 mH	17 mH/Q
Po	8 mW	IIA	2.1 µF	1000 mH	35 mH/Q

Module 9116B2		Group	Co	Lo	Lo/Ro
Terminal 51-53					
Uo	21.4 V	IIC	0.16 µF	1000 mH	4 mH/Q
Io	1.1 mA	IIB	1.13 µF	1000 mH	17 mH/Q
Po	8 mW	IIA	4.15 µF	1000 mH	35 mH/Q

Module 9116B1		Group	Co	Lo	Lo/Ro
Terminal 51-52					
Uo	8.3 V	IIC	7 µF	1000 mH	100 mH/Q
Io	0.2 mA	IIB	73 µF	1000 mH	400 mH/Q
Po	0.4 mW	IIA	1000 µF	1000 mH	800 mH/Q

Module 9116B2		Group	Co	Lo	Lo/Ro
Terminal 51-52					
Uo	8.3 V	IIC	7 µF	1000 mH	100 mH/Q
Io	0.2 mA	IIB	73 µF	1000 mH	400 mH/Q
Po	0.4 mW	IIA	1000 µF	1000 mH	800 mH/Q

Module 9116B1		Group	Co	Lo	Lo/Ro
Terminal 41,42,43,44					
Uo	8.3 V	IIC	7 µF	207 mH	1 mH/Q
Io	13.1 mA	IIB	73 µF	828 mH	5 mH/Q
Po	27.3 mW	IIA	1000 µF	1000 mH	10 mH/Q

Module 9116B2		Group	Co	Lo	Lo/Ro
Terminal 41,42,43,44					
Uo	8.3 V	IIC	7 µF	207 mH	1 mH/Q
Io	13.1 mA	IIB	73 µF	828 mH	5 mH/Q
Po	27.3 mW	IIA	1000 µF	1000 mH	10 mH/Q

Notas de instalação:

Instalação em grau de poluição 2, categoria de sobretensão II conforme definido no IEC 60664-1
 Não separe conectores quando energizado ou quando uma mistura de gás explosivo estiver presente.

Não monte ou remova módulos do trilho de alimentação quando uma mistura explosiva de gás estiver presente.

Desligue a alimentação antes da manutenção.

A fixação de terminais sem uso não é permitida.

A fonte de Loop e terminais de entrada de corrente para o mesmo canal não deve ser aplicada ao mesmo tempo.

Em tipo de proteção [Ex ia Da] os parâmetros para a segurança intrínseca para grupo de gás IIB são aplicáveis.

Para a instalação em Zona 2, o módulo deve ser instalado em um invólucro certificado conforme as normas da série ABNT NBR IEC 60079 que proporcione um grau de proteção de pelo menos IP54. Dispositivos de entrada de cabo e elementos de vedação devem cumprir com os mesmos requisitos.

Para a instalação de trilho de energia na Zona 2, apenas o trilho de alimentação Rail 9400 fornecido pela Unidade de Controle de Potência 9410 é permitido.

LERBAKKEN 10, 8410 ROENDE DENMARK

Área de Risco
Zone 0,1,2, 20, 21, 22

Área de não Risco
or Zone 2

$-20 \leq T_a \leq +60^\circ\text{C}$

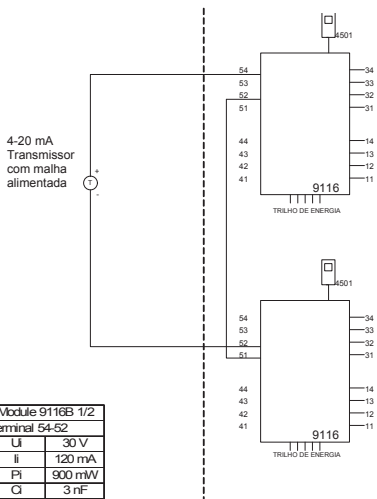

Module 9116B 1/2	
Terminal 54-52	
U _i	30 V
I _i	120 mA
P _i	900 mW
C _i	3 nF
L _i	2 µH

Module 9116B1					
Term. 54-52; 51-52		Group	Co	Lo	Lo/Ro
U _o	28 V	IIC	80 nF	4 mH	54 µH/Ω
I _o	93 mA	IIB	640 nF	16 mH	218 µH/Ω
P _o	650 mW	IIA	2.1 µF	32 mH	436 µH/Ω

Module 9116B2					
Term. 54-52; 51-52		Group	Co	Lo	Lo/Ro
U _o	21.4 V	IIC	0.16 µF	4 mH	54 µH/Ω
I _o	93 mA	IIB	1.13 µF	16 mH	218 µH/Ω
P _o	650 mW	IIA	4.15 µF	32 mH	436 µH/Ω

Rele de estado, terminais (33,34)

Instalação em área de não Risco
 Voltagem máx.: 125 VAC / 110 VDC
 Potência máx.: 62.5 VA / 32 W
 Corrente máx.: 0,5 A AC / 0,3 ADC

Instalação em Zona 2:
 Voltagem máx.: 32 VAC / 32 VDC
 Potência máx.: 16 VA / 32 W
 Corrente máx.: 0,5 A AC / 1 A DC

Rele de estado, terminais (13,14)

Instalação em área de não Risco
 Voltagem máx.: 250 VAC / 30 VDC
 Potência máx.: 500 VA / 60 W
 Corrente máx.: 2 A AC / 2 A DC

Instalação em Zona 2:
 Voltagem máx.: 32 V AC / 30 VDC
 Potência máx.: 64 VA / 60 W
 Corrente máx.: 2 A AC / 2 ADC

(terminais 11,12,13,14)
 (terminais 31,32,33,34)
 (terminais 91,92,93,94,95)
 U_m: 253 V máx. 400 Hz

Revision date:
2013-05-31

Version Revision
V6 R0

Prepared by:
PB

Page:
3/4

LERBAKKEN 10, 8410 ROENDE DENMARK

 Área de Risco
 Zona 0, 1, 2, 20, 21, 22

 Área de não Risco
 ou Zona 2

 $-20 \leq T_a \leq +60^{\circ}\text{C}$

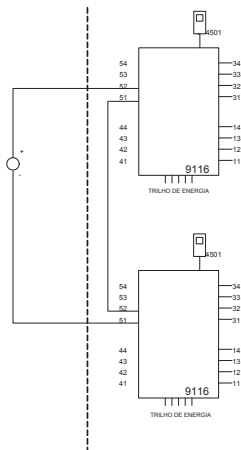
 0/4-20 mA
 Fonte de
 Corrente

Rele de estado, terminais (33,34)
Instalação em área de não Risco

 Voltagem máx.: 125 VAC / 110 VDC
 Potência máx.: 62.5 VA / 32 W
 Corrente máx.: 0,5 A AC / 0,3 ADC

Instalação em Zona 2:

 Voltagem máx.: 32 VAC / 30 VDC
 Potência máx.: 16 VA / 32 W
 Corrente máx.: 0,5 A AC / 1 A DC

Rele de estado, terminais (13,14)
Instalação em área de não Risco

 Voltagem máx.: 250 VAC / 30 VDC
 Potência máx.: 500 VA / 60 W
 Corrente máx.: 2 A AC / 2 ADC

Instalação em Zona 2:

 Voltagem máx.: 32 VAC / 30 VDC
 Potência máx.: 64 VA / 60 W
 Corrente máx.: 2 A AC / 2 ADC

(terminais 11,12,13,14)

(terminais 31,32,33,34)

(terminais 91,92,93,94,95)

 U_m: 253 V máx. 400 Hz

Module 9116B 1/2	
Terminal 51-52	
U _i	30 V
I _i	120 mA
P _i	900 mW
C _i	3 nF
L _i	2 μH

Module 9116B 1/2				
Term. 52-51, 51-52				
	Group	Co	Lo	Lo/Ro
U _o	IIC	0.4 μF	100 mH	25mH/Ω
I _o	IIB	2.3 μF	100 mH	100mH/Ω
P _o	IIA	9.5 μF	100 mH	200mH/Ω

 Revision date:
 2013-05-31

 Version Revision
 V6 R0

 Prepared by:
 PB

 Page:
 4/4

SAFETY MANUAL

UNIVERSAL CONVERTER 9116

This safety manual is valid for the following product versions:

9116-003

9116-002

9116-001

0 CONTENTS

1	Observed standards.....	3
2	Acronyms and abbreviations	3
3	Purpose of the product.....	3
4	Assumptions and restrictions for use of the product	4
4.1	Basic safety specifications	4
4.2	Safety accuracy	4
4.2.1	Minimum span	4
4.2.2	Range limitations	4
4.3	Associated equipment.....	4
4.3.1	RTD or linear resistance sensor wiring.....	4
4.3.3	Process calibration	5
4.3.4	Analogue output	5
4.3.5	Relay output.....	5
4.4	Failure rates	5
4.5	Safe parameterisation.....	5
4.6	Installation in hazardous areas	5
5	Functional specification of the safety function.....	5
6	Functional specification of the non-safety functions.....	6
7	Safety parameters.....	6
8	Hardware and software configuration.....	7
9	Failure category.....	8
10	Periodic proof test procedure	9
11	Procedures to repair or replace the product.....	9
12	Maintenance.....	9
13	Documentation for routing diagram.....	9
13.1	In general	9
13.2	Further explanations	9
13.2.1	Password protection.....	9
13.2.2	Sensor/cable fault information via display front 4501.....	10
13.3	Advanced functions (ADV.SET).....	10
13.3.1	Memory (MEM)	10
13.3.2	Display setup (DISP)	10
13.3.3	Password (PASS).....	10
13.3.4	Language (LANG).....	10
13.3.5	Process calibration (CAL)	10
13.3.6	Power rail (RAIL)	10
13.3.7	Simulation (SIM).....	11
13.3.8	Safety integrity level (SIL)	11
14	Safe parameterisation - user responsibility	11
14.1	Safety-related configuration parameters.....	11
14.1.1	Common parameters.....	11
14.1.2	Parameters related to Relay Output	14
14.1.3	Parameters related to analogue output.....	15
14.2	Verification procedure.....	16
14.2.1	If no password is set	17
14.2.2	If password is set	20
14.2.3	If any parameter is found to be incorrect during verification	20
14.3	Functional test	20

15	Fault reaction and restart condition	20
16	User interface	21
	16.2 Routing diagram	23
	16.3 Routing diagram - Advanced settings (ADV.SET).....	26
17	Connections diagram	27

1 Observed standards

Standard	Description
IEC 61508	Functional Safety of electrical / electronic / programmable electronic safety-related systems
IEC 61508-2:2000	Part 2: Requirements for electrical / electronic / programmable electronic safety-related systems
IEC 61508-3:1998	Part 3: Software requirements
IEC 61326-3-1:2008	Immunity requirements for safety-related systems

2 Acronyms and abbreviations

Acronym / Abbreviation	Designation	Description
Element		Term defined by IEC 61508 as “part of a subsystem comprising a single component or any group of components that performs one or more element safety functions”
PFD	Probability of Failure on Demand	This is the likelihood of dangerous safety function failures occurring on demand.
PFH	Probability of dangerous Failure per Hour	The term “Probability” is misleading, as IEC 61508 defines a Rate.
SFF	Safe Failure Fraction	Safe Failure Fraction summarises the fraction of failures which lead to a safe state and the fraction of failures which will be detected by diagnostic measures and lead to a defined safety action.
SIF	Safety Integrity Function	Function that provides fault detection (to ensure the necessary safety integrity for the safety functions)
SIL	Safety Integrity Level	The international standard IEC 61508 specifies four discrete safety integrity levels (SIL 1 to SIL 4). Each level corresponds to a specific probability range regarding the failure of a safety function.

3 Purpose of the product

Conversion and scaling of temperature (Pt, Ni and TC), voltage, potentiometer, linear resistance and current signals from hazardous area.

The device can be mounted in the safe area and in zone 2 / div. 2 and receive signals from zone 0, 1, 2, 20, 21 and 22 / Class I/II/III, Div. 1, Gr. A-G.

Error events, including cable faults, are monitored and signalled via the individual status relay and/or a collective electronic signal via the power rail.

The 9116 has been designed, developed and certified for use in SIL 2 applications according to the requirements of IEC 61508.

4 Assumptions and restrictions for use of the product

4.1 Basic safety specifications

Operational temperature range.....	-20...+60°C
Storage temperature range.....	-20...+85°C
Power supply type, min.....	Double or reinforced
Supply voltage	19.2...31.2 VDC
Relay output pulse length, min.	70 ms
Loop supply	>16.5 V @ 20 mA
External loop supply voltage	5...26 VDC + external drop (Passive output)
Mounting area.....	Zone 2 / Division 2 or safe area
Mounting environment.....	Pollution degree 2 or better

4.2 Safety accuracy

The analogue output and relay output corresponds to the applied input within the safety accuracy.

Safety accuracy $\pm 2\%$

4.2.1 Minimum span

For temperature measurements, the selected range (OUT.HI - OUT.LO), and for linear resistance measurements the selected range (R 100% - R 0%), shall be larger or equal to the values below:

Input type	Minimum span for safety accuracy
Pt100, Pt200, Pt1000	28°C
Pt500, Ni100, Ni120, Ni1000	43°C
Pt50, Pt400, Ni50	57°C
Pt250, Pt300	85°C
Pt20	142°C
Pt10	283°C
TC: E, J, K, L, N, T, U	91°C
TC: B, R, S, W3, W5, LR	153°C
Linear resistance, R 100% \leq 800 Ω	53 Ω
Linear resistance, R 100% $>$ 800 Ω	667 Ω

4.2.2 Range limitations

TC type B shall not be used below +400°C

4.3 Associated equipment

4.3.1 RTD or linear resistance sensor wiring

If a 2-wire or a 3-wire connection for RTD or linear resistance is selected,

the end user must ensure that the applied sensor wiring does not introduce failures exceeding the requirements for the safety application.

4.3.2 Sensor errors

If the loop supply is used to supply a current input signal, the sensor error indication shall be enabled on the safety output(s).

If sensor error detection is disabled, or if any of the configurations below are used, the user must ensure that the applied sensor, including wiring, has a failure rate that qualifies it for the safety application without sensor error detection enabled:

- Input is current, 0-20 mA
- Input is voltage
- Input is linear resistance and $R_{0\%} < 18 \Omega$ (no short circuit detection)
- Input is Pt10, Pt20 or Pt50 (no short circuit detection)
- Input is potentiometer (no short circuit detection on arm)

4.3.3 Process calibration

If a process calibration is taken into SIL-mode operation, it is mandatory that the accuracy of the device (and sensor, if applicable) are tested by the end user after SIL-mode is entered, in addition to the normal functional test. Refer to section 14 - Safe parameterisation - user responsibility.

4.3.4 Analogue output

The connected safety PLC shall be able to detect and handle the fault indications on the analogue output of the 9116 converter by having a NAMUR NE43-compliant current input.

4.3.5 Relay output

The relay output shall only be connected to equipment which has a current limiting function of 2 A.

4.4 Failure rates

The basic failure rates from the Siemens standard SN 29500 are used as the failure rate database.

Failure rates are constant, wear-out mechanisms are not included.

External power supply failure rates are not included.

4.5 Safe parameterisation

The user is responsible for verifying the correctness of the configuration parameters. (See section 14 Safe parameterisation - user responsibility).

Manual override may not be used for safety applications.

4.6 Installation in hazardous areas

The IECEx Installation drawing, ATEX Installation drawing and FM Installation drawing shall be followed if the products are installed in hazardous areas.

5 Functional specification of the safety function

Conversion of current signals (0...20 mA or 4...20 mA), voltage signals, potentiometer, linear resistance, RTD sensor signals or thermocouple sensor signals from hazardous areas to a 4...20 mA current output signal, and/or an output relay, within specified accuracy.

For RTD and linear resistance input sensors, cable resistances of up to 50 Ω per wire can be compensated if 3- or 4-wire connection is configured.

For thermocouple sensors, cold junction temperature errors can be compensated, either by an internally mounted temperature sensor, or by an accessory connector with a built-in temperature sensor. The selection of CJC measurement must be done and verified by the end user.

6 Functional specification of the non-safety functions

The status relay (terminal 33 and 34), error signal on power rail (terminal 91) and LED outputs are not suitable for use in any Safety Instrumented Function.

7 Safety parameters

RTD, TC, LinR and Potentiometer input, Current output	
Probability of dangerous Failure per Hour (PFH)	4.30E-08
	Note ¹
Probability of failure on demand (PFD) - 1 year proof test interval	2.82E-04
Proof test interval (10% of loop PFD)	4 years
Safe Failure Fraction	93%
RTD, TC, LinR and Potentiometer input, Relay output	
Probability of dangerous Failure per Hour (PFH)	6.20E-08
	Note ¹
Probability of failure on demand (PFD) - 1 year proof test interval	4.03E-04
Proof test interval (10% of loop PFD)	3 years
Safe Failure Fraction	90%
Voltage input, Current output	
Probability of dangerous Failure per Hour (PFH)	5.60E-08
	Note ¹
Probability of failure on demand (PFD) - 1 year proof test interval	3.66E-04
Proof test interval (10% of loop PFD)	3 years
Safe Failure Fraction	93%
Voltage input, Relay output	
Probability of dangerous Failure per Hour (PFH)	7.60E-08
	Note ¹
Probability of failure on demand (PFD) - 1 year proof test interval	4.89E-04
Proof test interval (10% of loop PFD)	2 years
Safe Failure Fraction	91%

Current input, Current output	
Probability of dangerous Failure per Hour (PFH)	4.20E-08
	Note ¹
Probability of failure on demand (PFD) - 1 year proof test interval	2.77E-04
Proof test interval (10% of loop PFD)	5 years
Safe Failure Fraction	95%
Current input, Relay output	
Probability of dangerous Failure per Hour (PFH)	6.20E-08
	Note ¹
Probability of failure on demand (PFD) - 1 year proof test interval	4.00E-04
Proof test interval (10% of loop PFD)	3 years
Safe Failure Fraction	93%
Common Safety Parameters	
Demand response time	Signal input: < 0.5 seconds Potentiometer and linear resistance input < 0.65 seconds Temperature input: < 1.1 seconds
Demand mode	High
Demand rate	3000 seconds
Mean Time To Repair (MTTR)	24 hours
Diagnostic test interval	30 seconds
Hardware Fault Tolerance (HFT)	0
Component Type	B
SIL capability	SIL 2
Description of the "Safe State", analogue output	Output ≤ 3.6 mA or Output ≥ 21 mA
Description of the "Safe State", relay output	Contact open (relay de-energized)
Relay lifetime (Note ²)	100 000 times

Note¹: The 9116 contains no lifetime limiting components, therefore the PFH figures are valid for up to 12 years, according to IEC 61508.

Note²: The user must calculate the product lifetime with regard to the relay lifetime.

8 Hardware and software configuration

All configurations of software and hardware versions are fixed from factory, and cannot be changed by end-user or reseller.

This manual only covers products labelled with the product version (or range of versions) specified on the front page.

9 Failure category

Failure rates (1/h) for RTD, TC, LinR and Potentiometer input, Current output	
Fail Safe Detected	0.000E-0
Fail Safe Undetected	2.78E-07
Fail Dangerous Detected	3.52E-07
Fail Dangerous Undetected	4.30E-08
Failure rates (1/h) for RTD, TC, LinR and Potentiometer input, Relay output	
Fail Safe Detected	0.000E-0
Fail Safe Undetected	3.59E-07
Fail Dangerous Detected	2.30E-07
Fail Dangerous Undetected	6.20E-08
Failure rates (1/h) for Voltage input, Current output	
Fail Safe Detected	0.000E-0
Fail Safe Undetected	3.95E-07
Fail Dangerous Detected	4.79E-07
Fail Dangerous Undetected	5.60E-08
Failure rates (1/h) for Voltage input, Relay output	
Fail Safe Detected	0.000E-0
Fail Safe Undetected	4.80E-07
Fail Dangerous Detected	3.53E-07
Fail Dangerous Undetected	7.60E-08
Failure rates (1/h) for Current input, Current output	
Fail Safe Detected	0.000E-0
Fail Safe Undetected	4.44E-07
Fail Dangerous Detected	5.54E-07
Fail Dangerous Undetected	4.20E-08
Failure rates (1/h) for Current input, Relay output	
Fail Safe Detected	0.000E-0
Fail Safe Undetected	6.36E-07
Fail Dangerous Detected	3.20E-07
Fail Dangerous Undetected	6.20E-08

10 Periodic proof test procedure

Step	Action
1	Bypass the safety PLC or take other appropriate action to avoid a false trip
2	Connect a simulator identical to the input setup
3	Apply input value corresponding to 0/100% output range
4	Observe whether the outputs acts as expected
5	Restore the input terminals to full operation
6	Remove the bypass from the safety PLC or otherwise restore normal operation

This test will detect approximately 95% of possible “du” (dangerous undetected) failures in the device. The proof test is equivalent to the functional test.

11 Procedures to repair or replace the product

Any failures that are detected and that compromise functional safety should be reported to the sales department at PR electronics A/S.

Repair of the device and replacement of circuit breakers must be done by PR electronics A/S only.

12 Maintenance

No maintenance required.

13 Documentation for routing diagram

The routing diagram is shown in section 16.2.

13.1 In general

When configuring the 9116, you will be guided through all parameters and you can choose the settings which fit the application. For each menu there is a scrolling help text which is automatically shown in line 3 on the display.

Configuration is carried out by use of the 3 function keys:

- ⏪ will increase the numerical value or choose the next parameter
- ⏩ will decrease the numerical value or choose the previous parameter
- ⏹ will accept the chosen value and proceed to the next menu

When configuration is completed, the display will return to the default state 1.0.

Pressing and holding ⏹ will return to the previous menu or return to the default state (1.0) without saving the changed values or parameters.

If no key is activated for 1 minute, the display will return to the default state (1.0) without saving the changed values or parameters.

13.2 Further explanations

13.2.1 Password protection

Access to the configuration can be blocked by assigning a password. The password is saved in the device in order to ensure a high degree of protection against unauthorised modifications to the configuration. Default password 2008 allows access to all configuration menus.

Password protection is mandatory in SIL applications.

13.2.2 Sensor/cable fault information via display front 4501

When the function is enabled and supported by selected input type, sensor or cable faults are displayed as SE.BR (sensor break) or SE.SH (cable short-circuited).

In case of sensor or cable fault the backlight flashes. This can be reset by pressing the  key. When the sensor or cable fault has been remedied, the device will return to normal operation.

13.3 Advanced functions (ADV.SET)

The device gives access to a number of advanced functions which can be reached by answering "Yes" to the point "ADV.SET".

13.3.1 Memory (MEM)

In the memory menu a non-SIL configuration can be either saved or loaded from the local memory of the 4501 display unit. Choose SAVE to store the current configuration in the 4501 memory. Press LOAD to read a previously stored configuration in the 4501 memory and store it in the device. It is only possible to load a configuration stored from the same type of device and from the same version, or earlier.

13.3.2 Display setup (DISP)

The brightness contrast and the backlight can be adjusted.

Tag number with 5 alphanumeric characters can be entered.

Functional readout in line 3 of the display can be selected: choose between readout of output current or tag no. When selecting "ALT" the readout alternates between output current and tag no.

13.3.3 Password (PASS)

Here you can choose a password between 0000 and 9999 in order to protect the device against unauthorised modifications to the configuration. The device is delivered default without password.

13.3.4 Language (LANG)

In this menu you can choose between 7 different language versions of help texts that will appear in the menu. You can choose between UK, DE, FR, IT, ES, SE and DK.

13.3.5 Process calibration (CAL)

A process calibration can be made by the end user. A known process signal must be applied for both low and high end of the input measurement range. The known input of the applied low end signal must be entered in the CAL.LO menu and confirmed by pressing OK before removing or changing the applied signal to the high end signal. The known input of the applied high end signal must be entered in the CAL.HI menu and confirmed by pressing OK before removing. It is possible to enable or disable the use of the latest process calibration.

13.3.6 Power rail (RAIL)

In this menu it can be chosen if sensor errors are transmitted to the central surveillance in the PR 9410 power control device.

13.3.7 Simulation (SIM)

It is possible to override the actual measured input signal by a simulated value. In the REL.SIM menu it is possible to simulate the relay state without affecting the analogue output, by pressing . Leaving the simulation menus, or disconnecting the 4501 device, will disable the simulation mode and bring the output back to correspond to the actual measured value. Simulation is not possible in SIL-mode.

13.3.8 Safety integrity level (SIL)

See section 14 - Safe parameterisation - user responsibility

14 Safe parameterisation - user responsibility**14.1 Safety-related configuration parameters****14.1.1 Common parameters**

Name	Function
IN.TYPE	Selected input type: TEMP = Temperature CURR = Current VOLT = Voltage LIN.R = Linear resistance POTM = Potentiometer
I.RANGE	Selected fixed input range for current measurements (for IN.TYPE = CURR): 0_20 = 0...20 mA (no sensor error detection!) 4_20 = 4...20 mA
V.RANGE	Selected fixed input range for voltage measurements (for IN.TYPE = VOLT)
SENSOR	Selected temperature sensor type (for IN.TYPE = TEMP): TC = Thermocouple Ni = Ni RTD sensor Pt = Pt RTD sensor

Pt.TYPE	Pt sensor type (for SENSOR = Pt): 10 = Pt10 20 = Pt20 50 = Pt50 100 = Pt100 200 = Pt200 250 = Pt250 300 = Pt300 400 = Pt400 500 = Pt500 1000 = Pt1000
Ni.TYPE	Ni sensor type (for SENSOR = Ni): 50 = Ni50 100 = Ni100 120 = Ni120 1000 = Ni1000
TC.TYPE	Thermocouple type (for SENSOR = TC): TC.B = Thermocouple type B TC.E = Thermocouple type E TC.J = Thermocouple type J TC.K = Thermocouple type K TC.L = Thermocouple type L TC.N = Thermocouple type N TC.R = Thermocouple type R TC.S = Thermocouple type S TC.T = Thermocouple type T TC.U = Thermocouple type U TC.W3 = Thermocouple type W3 TC.W5 = Thermocouple type W5 TC.Lr = Thermocouple type Lr
CJC	CJC type for SENSOR = TC: INT = Internal CJC sensor measurement CONN = CJC connector measurement (accessory)

CONNEC	<p>Selected sensor connection type for RTD or linear resistance measurements (for SENSOR = Ni or Pt or IN.TYPE = LIN.R): 2W = 2-wire 3W = 3-wire 4W = 4-wire</p> <p>If 2W or 3W is selected, the end user must ensure that the applied sensor wiring does not introduce failures exceeding the requirements for the safety application.</p>
R 0%	<p>0% input range for linear resistance measurements (for IN.TYPE = LIN.R). This value must be $< (R\ 100\% - \text{minimum span})$, refer to 4.2.1</p>
R 100%	<p>100% input range for linear resistance measurements (for IN.TYPE = LIN.R) This value must be $> (R\ 0\% + \text{minimum span})$, refer to 4.2.1</p>
UNIT	<p>Selected temperature unit for IN.TYPE = TEMP °C = degrees Celsius °F = degrees Fahrenheit For IN.TYPE \neq TEMP selectable units refer to routing diagram</p>
DISPLO	<p>0% display value on 4501. Can be used as base for relay setpoints (for IN.TYPE \neq TEMP)</p>
DISPHI	<p>100% display value on 4501. Can be used as base for relay setpoints (for IN.TYPE \neq TEMP)</p>
NEW.PAS	<p>Password for protection of the device configuration from unauthorized access. Range from 0 to 9999.</p>

14.1.2 Parameters related to Relay Output

REL.UNI	Relay Units (for IN.TYPE ≠ TEMP): PERC = Relay setpoint in percent of input range. DISP = Relay setpoints and hysteresis values relates to DISP.LO and DISP.HI (display units)
REL.FUN	Relay Function: OFF (Note ³) = Relay is always OFF POW (Note ³) = Relay is always ON if power is applied ERR = Relay is activated when sensor error is present WIND = Relay is activated when input signal is between SETP.LO and SETP.HI values SETP = Relay is activated when input signal reaches SETP value
CONTAC.	Relay contact function: N.C. = Normally Closed relay contact (for REL.FUN = SETP) N.O. = Normally Open relay contact (for REL.FUN = SETP) O.I.W = Relay contact Open Inside Window (for REL.FUN = WIND) C.I.W = Relay contact Closed Inside Window (for REL.FUN = WIND)
SETP.	Relay setpoint value in REL.UNI units for IN.TYPE ≠ TEMP or in UNIT for IN.TYPE = TEMP. (for REL.FUN = SETP)
SETP.LO	Relay setpoint low value in REL.UNI units for IN.TYPE ≠ TEMP or in UNIT for IN.TYPE = TEMP. (for REL.FUN = WIND)
SETP.HI	Relay setpoint high value in REL.UNI units for IN.TYPE ≠ TEMP or in UNIT for IN.TYPE = TEMP. (for REL.FUN = WIND)
ACT.DIR	Relay action for increasing or decreasing input signal (for REL.FUN = SETP): DECR = Relay activates when input signal ≤ SETP. INCR = Relay activates when input signal ≥ SETP.
HYST	Hysteresis value in REL.UNI units for IN.TYPE ≠ TEMP or in UNIT for IN.TYPE = TEMP. (for REL.FUN = SETP or WIND)

ERR.ACT	Relay sensor error action (for REL.FUN = SETP, WIND or ERR): Only relevant if IN.TYPE = TEMP, CURR and I.RANGE = 4-20, POTM or LIN.R and R 0% is ≥ 18 . NONE (Note ³) = Sensor error detection NOT enabled (Note ⁴), relay state at sensor error is undefined. (NOT for REL.FUN = ERR) OPEN = Relay contact is open at sensor error CLOS = Relay contact is closed at sensor error HOLD (Note ³) = Relay contact holds the state as before sensor error occurred. (NOT for REL.FUN = ERR)
ON.DEL	Relay ON delay from SETP or SETP.LO/HI is crossed in units of seconds (for REL.FUN = SETP or WIND)
OFF.DEL	Relay OFF delay from SETP +/- HYST or SETP.LO/HI +/- HYST is crossed in units of seconds (for REL.FUN = SETP or WIND)

Note³: Value not allowed if the relay is used in a safety application (EN.SIL = YES) and IN.TYPE = CUR and loop supply is used to supply a current input signal.

Note⁴: Error detection is enabled if OUT.ERR \neq none, but relay state at sensor errors undefined.

14.1.3. Parameters related to analogue output

Name	Function
O.RANGE	Fixed output range for current output: 0-20 = 0...20 mA Value not allowed when EN.SIL = YES (Safety applications) 4-20 = 4...20 mA 20-0 = 20...0 mA Value not allowed when EN.SIL = YES (Safety applications) 20-4 = 20...4 mA
OUT.ERR	Fixed output value on detected sensor error: NONE (Note ⁵) = Sensor error detection NOT enabled (Note ⁶), output at sensor error is undefined. The end user must ensure that the applied sensor including wiring has a failure rate qualifying it for the safety application without the detection enabled. 0 mA = Output is 0 mA at sensor error 3.5 mA = Output is 3.5 mA at sensor error (NE43 downscale) 23 mA = Output is 23 mA at sensor error (NE4 upscale)

OUT.LO	Selected temperature value for 0% output for IN.TYPE = TEMP in units defined by the UNIT parameter (°C or °F) Range is defined by the selected temperature sensor (SENSOR and TC.TYPE, Ni.TYPE or Pt.TYPE), but value must be less than OUT.HI - minimum span.
OUT.HI	Selected temperature value for 100% output for IN.TYPE = TEMP in units defined by the UNIT parameter (°C or °F). Range is defined by the selected temperature sensor (SENSOR and TC.TYPE, Ni.TYPE or Pt.TYPE), but must be larger than OUT.LO + minimum span.
RESP	Analogue output response time in seconds. Range is 0.0 to 60.0 seconds.
USE.CAL	Use the applied process calibration values: NO = The last performed process calibration is not used. The channel operates with accuracy as specified. YES = The last performed process calibration is in operation. The required accuracy must be verified by user. End user must verify by test that the applied process calibration does not introduce failures exceeding the requirements for the safety application.

Note⁵: Value not allowed if analogue output is used in a safety application (EN.SIL = YES) and IN.TYPE = CURR and loop supply is used to supply a current input signal.

Note⁶: Error detection is enabled if ERR.ACT ≠ NONE, but analogue output value is undefined.

14.2. Verification procedure

The verification is done using the display / programming front PR 4501 and following the procedure described below.

14.2.1 If no password is set

	Action	Display shows
1	Press OK	ADV.SET
2	Set (ADV.SET) to Yes and press OK	SETUP
3	Set SETUP to SIL and press OK	EN.SIL
4	Set EN.SIL to YES and press OK	NEW.PAS
5	Set password to a number between 0 and 9999 and press OK (At this time the device starts operating in SIL mode with the entered configuration parameters!)	CONFIG Verify OPEN->LOCK (Note ⁷)
6	Press OK to confirm verification of the OPEN->LOCK in the display	IN.TYPE
7	Verify input type and press OK	I.RANGE
8	Verify fixed input current range and press OK (ONLY if IN.TYPE = CURR)	CONNEC
9	Verify sensor connection type and press OK (ONLY if IN.TYPE = TEMP and SENSOR = Ni or Pt or IN.TYPE = LIN.R)	UNIT
10	Verify temperature unit and press OK (ONLY if IN.TYPE = TEMP)	SENSOR
11	Verify temperature sensor type and press OK (ONLY if IN.TYPE = TEMP)	Pt.TYPE
12	Verify Pt sensor type and press OK (ONLY if IN.TYPE = TEMP and SENSOR = Pt)	Ni.TYPE
13	Verify Ni sensor type and press OK (ONLY if IN.TYPE = TEMP and SENSOR = Ni)	TC.TYPE
14	Verify Thermocouple type and press OK (ONLY if IN.TYPE = TEMP and SENSOR = TC)	CJC

Note⁷: Open is shown briefly in the display.

	Action	Display shows
15	Verify CJC type and press OK (ONLY if IN.TYPE = TEMP and SENSOR = TC)	V.RANGE
16	Verify fixed input voltage range and press OK (ONLY if IN.TYPE = VOLT)	R 0%
17	Verify input resistance 0% range and press OK (ONLY if IN.TYPE = LIN.R)	R 100%
18	Verify input resistance 100% range and press OK (ONLY if IN.TYPE = LIN.R)	UNIT
19	Verify display units for 4501 and press OK (ONLY if IN.TYPE ≠ TEMP)	DEC.P
20	Verify display decimal point for 4501 and press OK (ONLY if IN.TYPE ≠ TEMP)	DISP.LO
21	Verify display value for 4501 at 0% input and press OK (ONLY if IN.TYPE ≠ TEMP)	DISP.HI
22	Verify display value for 4501 at 100% input and press OK (ONLY if IN.TYPE ≠ TEMP)	REL.UNI
23	Verify relay setpoint units and press OK (ONLY if IN.TYPE ≠ TEMP)	REL.FUN
24	Verify relay function and press OK	CONTAC.
25	Verify relay contact function and press OK (ONLY if REL.FUN ≠ OFF or POW)	SETP.
26	Verify relay setpoint and press OK (ONLY if REL.FUN = SETP)	SETP.LO
27	Verify low setpoint value and press OK (ONLY if REL.FUN = WIND)	SETP.HI
28	Verify high setpoint value and press OK (ONLY if REL.FUN = WIND)	ACT.DIR

	Action	Display shows
29	Verify relay activation direction and press OK (ONLY if REL.FUN = SETP)	HYST
30	Verify relay setpoint hysteresis and press OK (ONLY if REL.FUN = SETP or WIND)	ERR.ACT
31	Verify relay action on sensor error and press OK (ONLY if REL.FUN = SETP, WIND or ERR and the selected input type and range support sensor error detection, refer to section 4.3.2)	ON.DEL
32	Verify relay ON delay and press OK (ONLY if REL.FUN = SETP or WIND)	OFF.DEL
33	Verify relay OFF delay and press OK (ONLY if REL.FUN = SETP or WIND)	O.RANGE
34	Verify fixed output range for current output	OUT.ERR
35	Verify fixed output value on detected sensor error and press OK (ONLY if IN.TYPE ≠ VOLT, or IN.TYPE = CURR and I.RANGE ≠ 0-20 mA)	OUT.LO
36	Verify temperature for 0% output and press OK (ONLY if IN.TYPE = TEMP)	OUT.HI
37	Verify temperature for 100% output and press OK (ONLY if IN.TYPE = TEMP)	RESP
38	Verify analogue output response time and press OK	CH1.CAL
39	Verify the use of applied process calibration values and press OK	PASSW.
40	Verify password and press OK	SIL.OK
41	Verify SIL mode within 1 second	

14.2.2 If password is set

	Action	Display shows
1	Press OK	PASSW
2	Enter password and press OK	ADV.SET
3	Set ADV.SET to Yes and press OK	SETUP
4	Set SETUP to SIL and press OK	EN.SIL
5	Set EN.SIL to YES and press OK (At this time the device starts operating in SIL mode with the entered configuration parameters!)	CONFIG Verify OPEN->LOCK (Note ⁸)
6 to 41	As step 6 to 41 for 14.2.1	As step 6 to 41 for 14.2.1

Note⁸: Open is shown briefly in the display

14.2.3 If any parameter is found to be incorrect during verification

Remove SIL-mode (by entering the password and selecting EN.SIL = NO).
Go through the setup menu and correct the parameter(s).
Repeat step 1 to 36 (with correct parameters).

14.3 Functional test

The user is responsible to make a functional test after verification of the safety parameters. The procedure for periodic proof test described in section 10 shall be used.

In addition, if a process calibration is taken into SIL-mode operation (refer to section 13.3 - Advanced functions), it is mandatory that the accuracy of the device (and sensor, if applicable) are tested.

15 Fault reaction and restart condition

When the 9116 detects a fault the outputs will go to Safe State, in which the outputs will be “de-energised”.

If the fault is application-specific (cable error detection) the 9116 will restart when the fault has been corrected.

Power cycle the device for bringing it out of Safe State.

16 User interface

- [01] Set correct password
- [02] Enter Advanced setup menu?
- [03] Select Temperature input
Select Potentiometer input
Select Linear resistance input
Select Current input
Select Voltage input
- [04] Select 0.0-1 V input range
Select 0.2-1 V input range
Select 0-5 V input range
Select 1-5 V input range
Select 0-10 V input range
Select 2-10 V input range
- [05] Select 0-20 mA input range
Select 4-20 mA input range
- [06] Select 2-Wire sensor connection
Select 3-Wire sensor connection
Select 4-Wire sensor connection
- [07] Set Resistance value low
- [08] Set Resistance value high
- [09] Select Celsius as temperature unit
Select Fahrenheit as temperature unit
- [10] Select TC sensor type
Select Ni sensor type
Select Pt sensor type
- [11] Select Display unit
- [12] Select Decimal point position
- [13] Set Display range low
- [14] Set Display range high
- [15] Select Relay setpoint in % of input range
Select Relay setpoint in display units
- [16] Select Pt10 sensor type
Select Pt20 sensor type
Select Pt50 sensor type
Select Pt100 sensor type
Select Pt200 sensor type
Select Pt250 sensor type
Select Pt300 sensor type
Select Pt400 sensor type
Select Pt500 sensor type
Select Pt1000 sensor type
- [17] Select Ni50 sensor type
Select Ni100 sensor type
Select Ni120 sensor type
Select Ni1000 sensor type
- [18] Select TC-B sensor type
Select TC-E sensor type
Select TC-J sensor type
Select TC-K sensor type
Select TC-L sensor type
Select TC-N sensor type
Select TC-R sensor type
Select TC-S sensor type
Select TC-T sensor type
Select TC-U sensor type
Select TC-W3 sensor type
Select TC-W5 sensor type
Select TC-Lr sensor type
- [19] Select OFF function - relay is permanently off
Select POWER function - relay indicates power status OK
Select ERROR function - relay indicates sensor error only
Select WINDOW function - relay is controlled by 2 setpoints
Select SETPOINT function - relay is controlled by 1 setpoint
- [20] Select Normally Closed contact
Select Normally Open contact
- [21] Set Relay setpoint
- [22] Select Action on decreasing signal
Select Action on increasing signal
- [23] Set Relay hysteresis
- [24] Select No error action - undefined status at error
Select Open relay contact at error
Select Close relay contact at error
Select Hold relay status at error
- [25] Set Relay ON delay in seconds
- [26] Set Relay OFF delay in seconds
- [27] Select Contact is Closed Inside Window
Select Contact is Open Inside Window
- [28] Set Relay window setpoint low
- [29] Set Relay window setpoint high
- [30] Set Relay window hysteresis
- [31] Select Internal temperature sensor
Select CJC connector (Accessory)
- [34] Select Open relay contact at error
Select Close relay contact at error
- [37] Select 0-20 mA output range
Select 4-20 mA output range
Select 20-0 mA output range
Select 20-4 mA output range
- [38] Select No error action - output undefined at error
Select Downscale at error
Select Namur NE43 downscale at error
Select Namur NE43 upscale at error
- [39] Select Analogue output response time in seconds.
- [41] Set Temperature for analogue output low
- [42] Set Temperature for analogue output high
- [43] Enter SIL setup
Enter Simulation mode
Enter Rail setup
Perform Process Calibration
Enter Language setup
Enter Password setup
Enter Display setup
Perform Memory operations
- [44] Load saved configuration into module
Save configuration in display front
- [45] Adjust LCD contrast
- [46] Adjust LCD backlight
- [47] Write a 5-character channel TAG
- [48] Show Analog output value in display
Show TAG on display
Alternate shown information in display
- [49] Calibrate Input low to process value?
- [50] Calibrate Input high to process value?
- [51] Enable input simulation?
- [52] Set the input simulation value
- [53] Relay simulation - use \odot to toggle relay
- [54] Enable Password protection?
- [55] Set New password
- [56] Enable Fastset functionality?
- [57] Relay setpoint - press \odot to save

- [58] Relay setpoint - Read only
- [59] Select Language
- [60] Use process calibration values?
- [61] Set value for low calibration point
- [62] Set value for high calibration point
- [63] Enable Rail status signal output?
- [64] Enable SIL configuration lock?
0...20 mA is not a valid output range for SIL operation
- [65] is channel using process-compensated calibration data?
- [66] Configuration SIL status (Open / Locked)
- [80] Sensor short circuit
- [81] Sensor wire breakage
- [82] Display underrange
- [83] Display overrange
- [84] Input underrange
- [85] Input overrange
- [86] Input error - check input connections and reset power
- [87] Output error - check input connentions and reset power
- [88] Flash memory error - chek configuration
- [89] Invalid configuration type or version
- [90] Hardware error
- [91] CJC sensor error - check device temperature
- [92] CJC error - check CJC connector block
- [93] No communication

16.2 Routing diagram

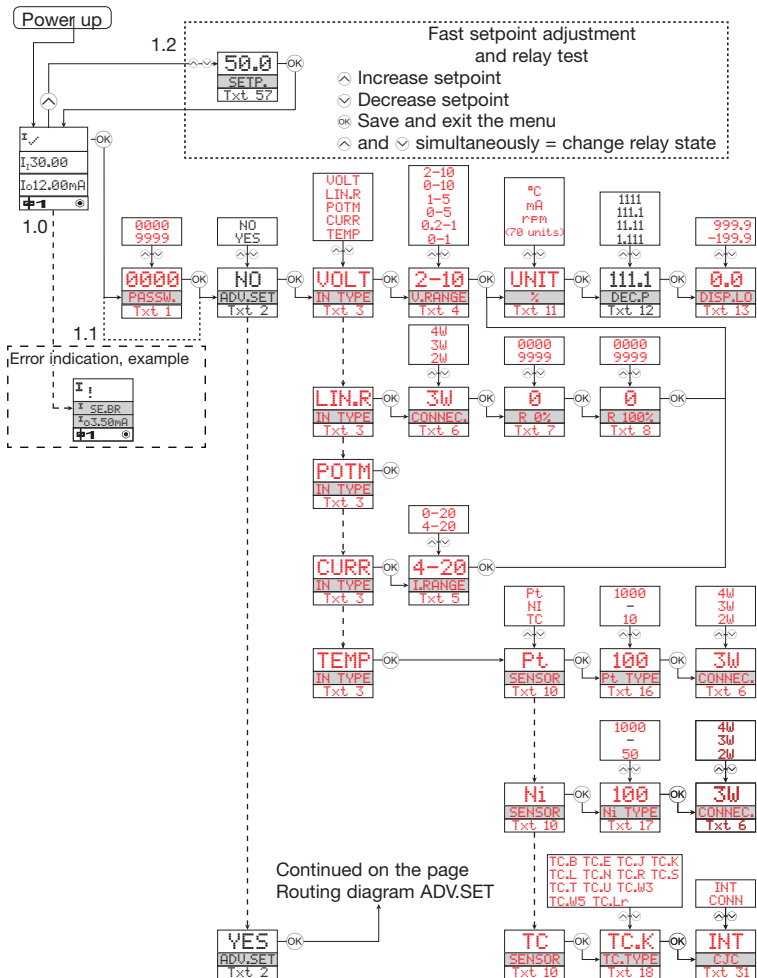

ROUTING DIAGRAM

If no key is activated for 1 minute, the display will return to the default state 1.0 without saving configuration changes.

- ⬆ Increase value / choose next parameter
- ⬇ Decrease value / choose previous parameter
- Ⓚ Accept the chosen value and proceed to the next menu
- Hold Ⓚ Back to previous menu / return to menu 1.0 without saving

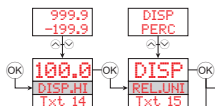

Continued on the next page

- 1.0 = Default state. Line 1 shows input status. Line 2 toggles between process value and UNIT. Line 3 shows output and TAG No. Line 4 shows status for relay and communication and whether the device is SIL-locked. Static dot = SIL-locked and flashing dot = not SIL-locked.
- 1.1 = Only if password-protected.
- 1.2 = Only if FastSet is activated and the relay function is setpoint.
- 1.3 = Only if input types support sensor error check. Not valid for these input signals: 0...20 mA and voltage.
- 1.4 = Only if input signal is temperature.
- 1.5 = Only if the configuration is not protected by a password.

Selectable UNITS:

°C	min	t	GW	m ³ /h
°F	m/s	kg	MW	l/s
K	mm/s	g	kW	l/min
%	m/min	N	hp	l/h
m	m/h	Pa	A	gal/min
cm	in/s	MPa	kA	gal/h
mm	ips	kPa	mA	t/h
um	ft/s	hPa	uA	mol
ft	in/min	bar	V	pH
in	ft/min	mbar	kV	[blank]
mils	in/h	kJ	mV	
yd	ft/h	Wh	ohm	
m ³	m/s ²	MWh	S	
l	rpm	kWh	uS	
s	Hz	W	m ³ /min	

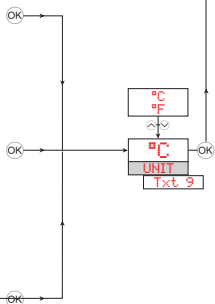

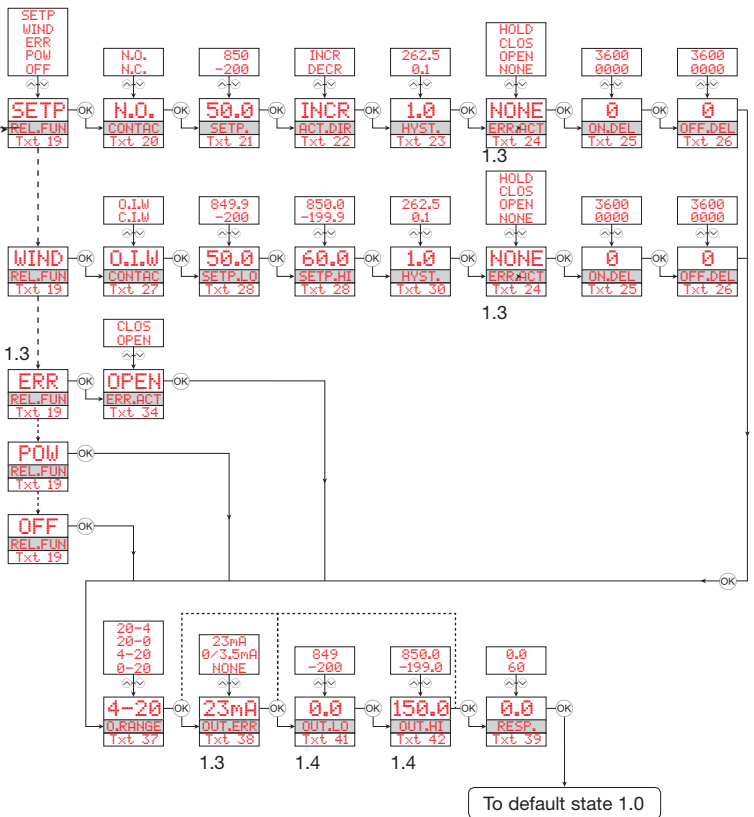

16.3 Routing diagram -
Advanced settings (ADV.SET)

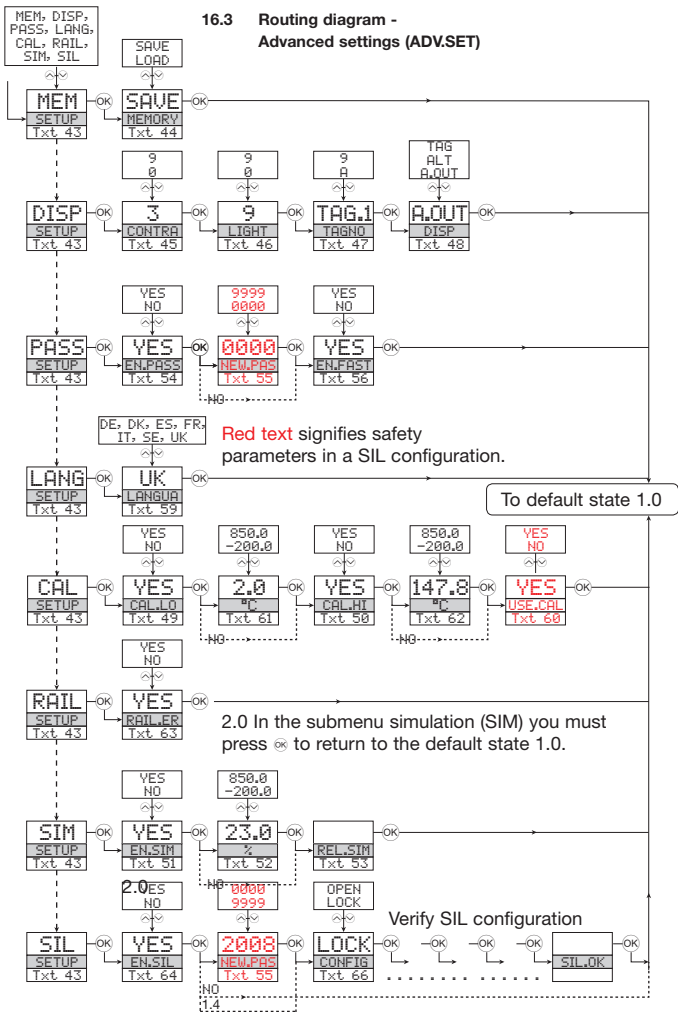

17 Connections diagram

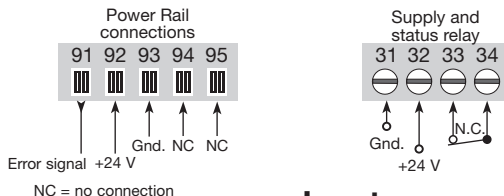

Inputs:

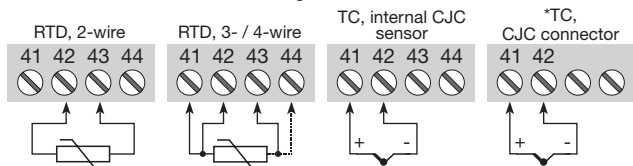

* Order separately:
CJC connector
5910Ex.

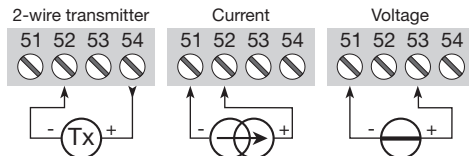
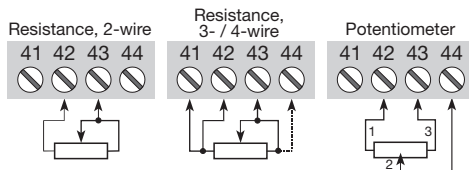

Outputs:

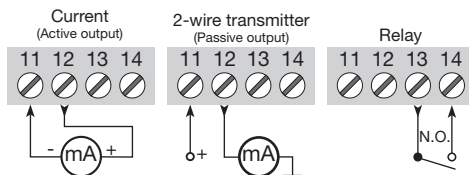



Displays

Programmable displays with a wide selection of inputs and outputs for display of temperature, volume and weight, etc. Feature linearization, scaling, and difference measurement functions for programming via PReset software.



Ex interfaces

Interfaces for analog and digital signals as well as HART® signals between sensors / I/P converters / frequency signals and control systems in Ex zone 0, 1 & 2 and for some devices in zone 20, 21 & 22.



Isolation

Galvanic isolators for analog and digital signals as well as HART® signals. A wide product range with both loop-powered and universal isolators featuring linearization, inversion, and scaling of output signals.



Temperature



























A wide selection of transmitters for DIN form B mounting and DIN rail devices with analog and digital bus communication ranging from application-specific to universal transmitters.



Universal

PC or front programmable devices with universal options for input, output and supply. This range offers a number of advanced features such as process calibration, linearization and auto-diagnosis.



- 
 www.preelectronics.fr
 sales-fr@preelectronics.com
- 
 www.preelectronics.de
 sales-de@preelectronics.com
- 
 www.preelectronics.es
 sales-es@preelectronics.com
- 
 www.preelectronics.it
 sales-it@preelectronics.com
- 
 www.preelectronics.se
 sales-se@preelectronics.com
- 
 www.preelectronics.com
 sales-uk@preelectronics.com
- 
 www.preelectronics.com
 sales-us@preelectronics.com
- 
 www.preelectronics.cn
 sales-cn@preelectronics.com
- 
 www.preelectronics.be
 sales-be@preelectronics.com

Head office

Denmark
 PR electronics A/S
 Lerbakken 10
 DK-8410 Rønne

www.preelectronics.com
sales-dk@preelectronics.com
 tel. +45 86 37 26 77
 fax +45 86 37 30 85



QUALITY SYSTEM AND ENVIRONMENTAL MANAGEMENT SYSTEM
 DS/EN ISO 9001
 DS/EN ISO 14001

